

Solutions for Radiation Medicine QA



Radiation Medicine Products from PTW

Ionizing Radiation

When the German physicist Wilhelm Conrad Röntgen discovered X-rays in 1895 and French physicist Antoine-Henri Becquerel discovered the nuclear radiation of uranium in 1896 (which Marie Curie later on called "radioactivity") they began a fascinating development in the science of ionizing radiation. Today, modern techniques in medical radiology are essential for human welfare as modern sciences and industrial production depend on the use of ionizing radiation.

Contrary to the many positive benefits, the major drawback of ionizing radiation is the radiation risk. When irradiated, healthy human tissue can be damaged. The higher the radiation load to a person, the higher the risk for the development of diseases. In the case of intended irradiation of patients in radiation medicine, the radiation exposure to healthy tissue should always be as low as possible. Quite a number of international standards and regulations have settled the principles of radiation protection for all fields of radiation use.

To ensure proper functioning of technical equipment producing ionizing radiation and to avoid unintended exposure, the radiation output and the equipment quality have to be checked carefully after installation and frequently over time. Since 1922, PTW Freiburg has been supplying specialized dosimeters to measure the quantity of ionizing radiation with different beam qualities in a most precise manner. A calibration laboratory has been in continuous operation to provide correct measurement of radiation quantities by the measuring equipment from PTW production from the beginning. In addition, test tools for quality control of medical radiation equipment and radiation monitoring devices have always been part of the PTW product line.

Trademarks

The following product names are registered trademarks of PTW Freiburg and PTW North America:

Advanced Markus, BQ-CHECK, Bragg Peak, DAVID, DIAMENTOR, Markus, MEPHYSTO, microDiamond, MLCSoft, MultiCheck, NOMEX, NORMI, PinPoint, FARMER, QUICKCHECK, QUICKCHECK webline, ROOS, STARCHECK, STARCHECK Maxi, TRUFIX, UNIDOS, UNIDOS E, UNIDOS webline, VeriSoft, WEDGECHECK, X-Check

Microsoft and Windows are either registered trademarks or trademarks of Microsoft Corporation.

Product Information

Some of the products are used for multiple purposes. Therapy detectors, for example, are used for reference dosimetry in conjunction with an electrometer, and for relative dosimetry in conjunction with an automatic beam analyzer.

Many of the products presented in this catalog require the use of a computer. Due to fast technological progress, computer requirements are not included in the descriptions. We suggest that you contact us for advice about an appropriate solution in each case.

International Standards

The medical and electric products from PTW are manufactured in strict accordance with valid international standards. The medical products are CE marked in accordance with the European Medical Device Directive (MDD) or the European Medical Device Regulations (MDR).

Contents

▶ Introduction	4
<hr/>	
▶ Radiation Therapy	9
Reference Dosimetry	11
Therapy Beam Analysis	21
Quality Control	31
<hr/>	
▶ Diagnostic Imaging	49
Reference Dosimetry	51
Quality Control	57
Patient Dosimetry	65
<hr/>	
▶ Radiation Monitoring	69
<hr/>	
▶ Metrology	77
<hr/>	
▶ Quick View	91
TBA Therapy Beam Analyzers	94
Guide to PTW Dosemeters	96
Guide to PTW Software	97
Product Index	98
Item Number Index	99

“There is no good – unless you do it.”

Excerpt from the autobiography of Dr. Herbert Pychlau (1897-1971)



Dr. Herbert Pychlau, 1897-1971, physicist, owner and director of PTW from 1927 until 1971

“When I returned to Freiburg as a 27-year-old after a serious illness, I thought about what I wanted to do in my future professional life. I considered qualifying as a university lecturer. But in the end, fate would have it that I met Dr. Hammer (Dr. Pychlau’s supervisor (annotation of the translator)) in the street. He invited me to have a look at what he had been doing in the meantime and told me about his having set up a business for the production of his invention, a dose-meter based on an electrostatic relay. It was out of sheer friendship back then that I went on a series of trips either to set up dosimeters or to instruct their users in the operation. Dr. Hammer himself had serious financial difficulties to contend with and couldn’t take many trips owing to his official duties at the university.

In this way I came to know all the leading radiologists in person. After two years, the situation of Dr. Hammer’s business was so precarious that he wanted to close it. But, knowing how much the radiologists were in need of such a device and how highly they appreciated it, I thought it irresponsible to throw in the towel due to mere financial or secondary technical problems. Thanks to my efforts for the dosimeter, the radiologists on one hand as well as an important company in the radiology branch on the other had gained a lot of confidence in my person. The latter even agreed to back the further work of our business if I were willing to take over its management. And so that is how in the year 1927 I took over the direction of the PTW in an honorary capacity, as it were. Still I had to earn my living with the translation of patents. It was not until after several hard initial years that the business could pay me a salary. Dosimetry was an exceptionally interesting field of work in those years; so I stuck to it and abandoned all other plans I had once fostered.”



Dr. Wilhelm Hammer, 1885-1949, inventor of the relay-based Hammer dose-meter and founder of PTW



It set global standards for dosimeters: the first dose-meter designed by Dr. Hammer

Setting standards in dosimetry

In 1922, twenty-seven years after Röntgen discovered X-rays, Professor Hammer from the Physics Institute of Freiburg University founded PTW to produce and market his development of an X-ray dosimeter based on electrostatic relay, a revolutionary new electromechanical component for measuring very small electrical charges.

In 1927, Dr. Herbert Pychlau took over the company and developed it during four decades into an internationally recognized manufacturer of quality dosimeters for medical radiology.

During the second half of the 20th Century, the business grew into an acknowledged international company, acquiring a good reputation as a pioneer with both scientists and users.

Technical improvements from electrometer tubes and transistors to microprocessor control and computer communication modernized the growing spectrum of products. Increasing exports finally led to a further milestone in the company's history: the foundation of PTW North America as an independent subsidiary to distribute and service PTW products all over the American continent. In January 2002, PTW France was established. Subsidiaries in Rio de Janeiro, Hong Kong, Beijing, the UK, India, Spain, Russia and the Netherlands followed.



Global headquarters in Freiburg, Germany

PTW Freiburg's premises, which in the very beginning was located in Professor Hammer's garden shed, covers a total area of 20.000 m² today. PTW employs a staff of over 350 people all over the world. The company, which scores steady growth, is the recognized market leader in dosimetry today.

We at PTW constantly strive to be competent and reliable partners for our customers all over the world, which includes maintaining demanding quality standards as well as comprehensive service and support standards. We will continue our efforts to develop the most reliable and highest quality dosimetry products in the future as we have in the past, products in which users and patients put their trust. We are committed to upholding this trust, because we know what responsibility means.



Second production site in Umkirch, Germany



The rules of the market are stringent – so are our principles

PTW is the global market leader in all essential product lines, which is due to our historic commitment to first-class production – not mass production!

The fact that PTW systems, which were installed more than 30 years ago, are still being used testifies for the quality of our products.

In contrast to common practice, we still maintain a highly qualified R&D department. We also continue to design, develop, and produce whatever we consider useful in-house. And, unique to PTW, we structure sales in such a way that our customers realize that performance – not selling – is our motivation!

The areas of application of our products include radiation therapy, diagnostic radiology, and health physics. Our product range includes reference and relative dosimetry, quality control equipment and patient dosimetry for radiation therapy and diagnostic radiology, as well as, radiation monitoring in radiation protection.

Radiological calibration services are an essential part of our activities. PTW operates the first secondary standard dosimetry laboratory for ionizing radiation accredited by DAkkS (German Calibration Service) in Germany.

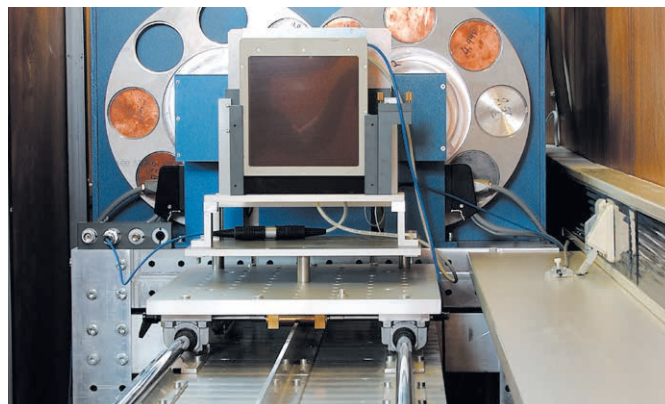

One out of eleven calibration benches at the PTW calibration lab

We perform radiological calibrations for dosimeters used in medical radiology and health physics, which are directly traceable to the primary standard. Our calibration lab provides a complete range of radiological calibrations from low X-ray energies up to ^{60}Co and from low to high dose rates. With eleven calibration benches in continual use, the accredited PTW calibration lab, which is under regular control of the national laboratory (Physikalisch-Technische Bundesanstalt, PTB), is one of the most active calibration labs for ionizing radiation in the world. PTW is also a member of the IAEA/WHO network for dosimetry in radiation therapy.



Detailed technical data for many of our products are available upon request. Contact your local PTW agent or order them via email.

Quantity can be counted – quality counts

PTW has always been a synonym for quality. Equipment from the company's initial years such as the second generation dosimeters, Simplex and Duplex, are still being used.

To our customers' utmost satisfaction and in the service of medical technology, PTW has committed itself to the design, development and production of high quality devices and systems. To do justice to these high expectations, PTW introduced a system of quality assurance at an early stage, which meets the requirements according to DIN ISO 9001 and EN 46001. Additionally, our quality management is constantly scrutinized, updated and adjusted to fulfill national and international standards. In this way, we ensure that our demands – and our products – not only comply with standards, but even surpass them.

Expanded service applications, customer support, and regular employee training sessions are just as much a part of our daily business as the continual promotion of innovative product ideas and developments.

Our medical products are CE-marked according to the European Medical Device Directive.

We introduced the testing and calibration of our products in realistic conditions as early as 1931. Today, our own in-house calibration laboratory is an essential component in ensuring the precision and reliability of our products.



Motivated and responsible staff: the basis for reliable medical products

Why we are close to our customers – onsite or remote

PTW products are well known for their outstanding reliability. Our service standards obligate us to repair and recalibrate each and every PTW product – regardless of where it is in operation.

This is by no means a typical practice, but we take pleasure in offering our customers the most comprehensive service and support possible.

For instance, PTW runs a service hotline, which provides professional advice to resolve minor problems free of charge. We also provide software and regular updates for our products, which you can obtain from your local PTW agent.

We have PTW agents on all continents which makes it possible to have PTW products shipped to Freiburg or one of our branches for repair and maintenance. We strongly recommend contacting your local PTW agent for recalibration of nearly all kinds of dosimetry equipment.

For details please visit our website at ptwdosimetry.com



Recalibration and repair: Just a selection of our after-sales services

Radiation Therapy



PTW Products for Medical Physics in Radiation Therapy

Introduction

Radiation therapy is one of the most powerful weapons for an effective fight against the painful disease of human cancer. The treatment techniques and the irradiation equipment have been developed continuously in the past to meet the goal of delivering radiation loads to cancer tissue in an optimal way and to protect patients against radiation damage. Dosimetry and quality assurance procedures are essential for precise radiation treatment and avoiding unintended irradiation.

Medical physics experts are responsible for the scientific and technical services and consultations in hospitals to guarantee correct cancer treatment using ionizing radiation. Medical physics in general is a branch of applied physics, and radiation therapy physics is the main area of activity of medical physicists worldwide. These physicists are trained to use special concepts and methods of physics to help diagnose and treat human disease, and they have collected practical experience dealing with medical problems and using equipment.

Because medical physics departments in radiation therapy are involved in therapy dosimetry and quality assurance procedures, they need to be equipped with appropriate measuring and test instruments to provide the best possible cancer treatment including modern treatment techniques.

Product Information

PTW offers a comprehensive range of measuring and test equipment for medical physics in radiation therapy. The products are of high quality and have been tried and tested to ensure that responsible medical physicists can fulfill their duties and provide continual patient treatment on high quality levels.

Medical physics in radiation therapy includes a number of different measuring and quality control tasks. Therefore, the chapter is divided into three subchapters:

▶ Reference Dosimetry

Presents dosimeters, electrometers, radiation detectors and calibration phantoms for reference calibrated dosimetry.

▶ Therapy Beam Analysis

Presents automatic measuring equipment for dose distribution measurement and analysis of therapy beams.

▶ Quality Control

Presents test equipment for various quality control procedures.

Reference Dosimetry

▶ UNIDOS Tango Electrometer	13
▶ UNIDOS Romeo Electrometer	13
▶ TANDEM Dual Channel Electrometers	14
▶ UniSoft Dosimetry Software	14
▶ Detectors for Ionizing Radiation	15
▶ Detector Extension Cables	15
▶ Build-Up Caps for Ionization Chambers	16
▶ MP1 Phantom Tanks	16
▶ Water Phantom 41001	17
▶ Water Phantom 41023	17
▶ ESTRO Mini Phantoms	18
▶ Brass Mini Phantoms	18
▶ RW3 Slab Phantom	18
▶ Radioactive Check Devices	19
▶ Barometers, Thermometer	19

Reference Dosimetry

Introduction

The quantification of ionizing radiation and the manufacture of reliable radiation dosimeters has been a challenge for medical physics experts since in 1895 W. C. Röntgen discovered the X-rays in Würzburg, Germany.

PTW Freiburg presented the first industrially produced therapy dosimeter, the Hammer dosimeter, in 1922, of which approximately 1000 units have been delivered. During the period of meanwhile ten decades PTW Freiburg developed, produced and distributed more than 10,000 units of high quality radiation detectors and electrometers for reference dosimetry in radiation therapy to the medical physics community around the world.

Product Information

The present product line includes a wide range of top level dosimeters, ionization chambers, solid state detectors, check devices and calibration phantoms in different designs for multiple dosimetry purposes. Radiation detectors, dosimeters and connection cables can be supplied with different connecting systems. When ordering radiation detectors, the appropriate connector code can be added to the chamber type number. The codes are N for BNT, W for TNC and M for PTW M type connectors.

Calibration

Since the first days PTW Freiburg put efforts to provide for accurate calibration of the radiation measuring instruments.

The calibration facilities and the content of the calibration certificates are described in the health physics chapter. When ordering ionization chambers please specify the desired calibration including beam quality, measuring quantity and reference temperature.

International Standards

The dosimeters are developed and produced in accordance with the international IEC standards. The UNIDOS Tango dosimeter as secondary standard dosimeter in addition is based on the IPEM guidelines. The dosimeters are used according to the international protocols for therapy dosimetry. The major standards are:

- ▶ IPEM Guidelines on dosimetry transfer instruments as a secondary standard dosimeter
- ▶ IAEA Report TRS-381
The Use of Plane Parallel Ionization Chambers in High Energy Electron and Photon Beams
- ▶ IAEA Report TRS-398
Absorbed Dose Determination in External Beam Radiotherapy: An International Code of Practice for Dosimetry based on Standards of Absorbed Dose to Water
- ▶ AAPM TG-25, Report #32
Clinical electron beam dosimetry
- ▶ AAPM TG-51, Report #67
Protocol for clinical reference dosimetry of high-energy photon and electron beams
- ▶ DIN 6800-2
Procedures of dosimetry with probe-type detectors for photon and electron radiation - Part 2: Ionization chamber dosimetry of high energy photon and electron radiation

UNIDOS Tango Reference Class Electrometer

Smart secondary standard reference class electrometer exceeding IEC 60731 and IPEM standards



- ▶ Reference class electrometer fully compliant with IEC 60731, IEC 61674, IEC 62467-1, IEC 60846 and JSMP (JCSS calibration needed)
- ▶ Secondary standard electrometer according to IPEM
- ▶ Automated detector management with Intelligent Detector Recognition (IDR)
- ▶ Best available resolution of 0.1 fA in the market
- ▶ Built-in webserver and LAN interface
- ▶ Can be controlled via smart device or PC (WLAN and LAN)
- ▶ Touchscreen with excellent readability from any viewing angle

UNIDOS Tango is a secondary standard reference class electrometer which meets and exceeds both IEC and IPEM performance requirements. With the best available resolution in the market of 0.1 fA, it is the perfect choice for high-precision measurements, e.g., in small field dosimetry.

UNIDOS Tango automates detector management and identification using Intelligent Detector Recognition. Simply scan the data matrix code on your calibration certificate or detector label with the built-in camera, and a new detector is added to the database or the right detector chosen for measurement. With its built-in webserver and LAN interface, UNIDOS Tango provides full remote control capabilities. Change settings or start measurements conveniently from your PC, view results instantly on your tablet or smartphone.

Ordering Information

L981629 UNIDOS Tango, connecting system M
L981630 UNIDOS Tango, connecting system BNT
L981631 UNIDOS Tango, connecting system TNC

Options

T10052.1.040 Carrying case
E41100B/S/G Service contract Bronze, Silver or Gold

UNIDOS Romeo Reference Class Electrometer

Standard reference class electrometer exceeding IEC 60731



- ▶ Reference class electrometer fully compliant with IEC 60731, IEC 61674 and IEC 62467-1
- ▶ Built-in detector database
- ▶ Resolution of 1 fA
- ▶ Touchscreen with excellent readability from any viewing angle

UNIDOS Romeo is a versatile reference class electrometer that exceeds IEC 60731 performance requirements. It comes with a resolution of 1 fA, which makes it a reliable tool for reference dose and quality assurance measurements across all major applications.

UNIDOS Romeo has been designed primarily for standalone use. It comes with an intuitive touchscreen interface, which gives you instant access to all important settings and options, making standalone operation very easy. With its user-friendly design, it is perfect for sites who want best-in-class measurement technology, but do not need multiple connectivity options. It provides an intuitive user interface and ready-to-use detector templates.

Ordering Information

L981632 UNIDOS Romeo, connecting system M
L981633 UNIDOS Romeo, connecting system BNT
L981634 UNIDOS Romeo, connecting system TNC

Options

T10052.1.040 Carrying case
E41100B/S/G Service contract Bronze, Silver or Gold

TANDEM Dual Channel Electrometers

Dual channel electrometers for reference dosimetry with BeamDose software and for relative dosimetry with TBA systems



- ▶ Dual channel therapy dosemeters in accordance with IEC 60731 (field class), resolution 10 fA (TANDEM XDR: 100 fA)
- ▶ XDR version with extended dose rate range for e.g. IORT
- ▶ Reference dose measurement with TanSoft software
- ▶ Fast scanning measurements in motorized water phantoms (time constant 10 ms)
- ▶ Accepts ion chambers and solid state detectors to be connected
- ▶ High resolution for small size ion chambers

The TANDEM electrometer is calibrated in electrical current (A). It can be operated by a PC as an reference therapy dosemeter. The BeamDose software provides calibration and correction factors for various detectors and displays the measurement results. The chamber voltage for both channels is individually programmable in 50 V increments up to 400 V with reversible polarity. The TANDEM is very fast and can be set to minimum measuring intervals of 10 ms. It features auto-range and offset compensation. It can perform radiation field measurements referenced to an ionization chamber. In conjunction with a TBA therapy beam analyzer, BEAMSCAN software controls TANDEM for fast and accurate beam data acquisition. A trigger input synchronizes measurements with external signals.

Ordering Information

- T10015 TANDEM electrometer, connecting system BNT
- T10016 TANDEM electrometer, connecting system TNC
- T10011 TANDEM electrometer, connecting system M
- T10038 TANDEM XDR electrometer, connecting system BNT
- T10039 TANDEM XDR electrometer, connecting system TNC
- T10037 TANDEM XDR electrometer, connecting system M

Option

- S080053 BeamDose software

UniSoft Dosimetry Software

Software for radiation therapy dosimetry according to international dosimetry protocols

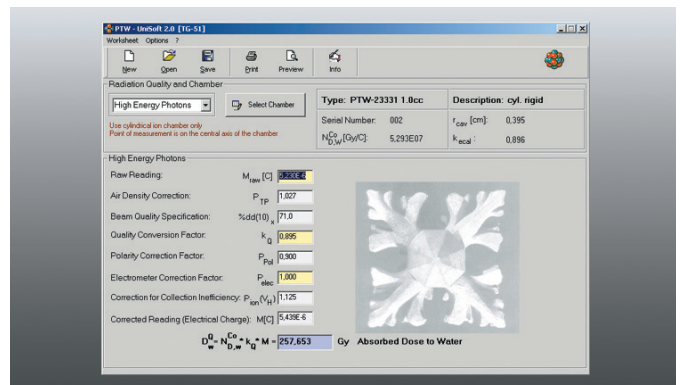

- ▶ Determines chamber correction factors and calculates absorbed dose to water
- ▶ Put out data in worksheet format
- ▶ Two versions are available to support all established international therapy dosimetry protocols

The UniSoft software is designed to determine the absorbed dose to water of high-energy photon and electron radiation out of dosemeter readings from ionization chambers based on ⁶⁰Co calibrations.

UniSoft software, Edition 2000 supports the AAPM TG-51 and IAEA TRS-398 therapy dosimetry protocols by calculating the relevant correction factors for air density, polarity effect, saturation effect, radiation quality and displacement. A software module to control the dose meter and to position the detector is included.

UniSoft features ionization chamber libraries to store chamber data necessary for the determination of correction factors. Dosimetry worksheets can be defined for different dosimetry protocols, beam qualities, types of ionization chambers and two kinds of air density correction.

Ordering Information

- S100009 UniSoft software, Edition 2000

Detectors for Ionizing Radiation

Ionization chambers and solid state detectors for reference and relative dosimetry



PTW provides a wide range of detectors for ionizing radiation. The product range includes detectors for relative dosimetry, reference dosimetry, small field dosimetry, FFF dosimetry and proton dosimetry. MR conditional detectors are also available.

Detectors available include:

- 0.6 cm³ Farmer Chamber, waterproof, type 30013
- 0.6 cm³ Farmer Chamber, PMMA/Al, type 30010
- 0.6 cm³ Farmer Chamber, Graphite/Al, type 30012
- 0.07 cm³ Semiflex 3D Chambers, types 31021/31024 (MR)
- 0.125 cm³ Semiflex Chamber, type 31010
- 0.3 cm³ Semiflex Chamber, type 31013
- 0.016 cm³ PinPoint 3D Chambers, types 31022/31025 (MR)
- 0.03 cm³ PinPoint Chamber, type 31015
- microSilicon for Electrons and Photons, type 60023
- microSilicon X for Photons, type 60022
- microDiamond, type 60019
- T-REF Chamber, type 34091
- 0.35 cm³ Roos Electron Chamber, type 34001
- 0.02 cm³ Advanced Markus Electron Chamber, type 34045
- 0.005 cm³ Soft X-ray Chamber, type 34013
- 0.02 cm³ Soft X-ray Chamber, type 23342
- 10.5 cm³ Bragg Peak Chambers, types 34070/34080
- 34 cm³ Bragg Peak 150 Chamber, type 34089

For further information refer to our product catalog "Detectors for Ionizing Radiation" available for download at ptwdosimetry.com.

There you will also find the "Detector Selector", a smart online tool that will help you to find the best detector for your application.



Detector Extension Cables

High quality triax extension cables with BNT, TNC and PTW M connectors



- ▶ Serve as low noise triax cables for the connection of radiation detectors to electrometers
- ▶ Low cable leakage caused by irradiation
- ▶ Resistance against radiation damage
- ▶ Available in lengths of up to 100 meters

The low noise extension cables for the connection of radiation detectors to electrometers are of high quality for precise current measurements down to 10^{-15} A. When irradiated, the cable leakage is less than 10^{-12} C/(Gy·cm). The triaxial cables provide insulated potentials for the measuring signal, the guard electrode, and high voltage. Extension cables of 20 m length can be supplied on cable reels. The cables can be supplied with various connector types. The BNT connector with bayonet mounting and the TNC connector with threaded mounting put high voltage to the chamber guard ring while the PTW M connector grounds the guard. For through-wall installations, the extension cables with BNT, TNC, and M connectors can be supplied with a flexible armored metal tube to protect the cable against damage.

Ordering Information

- T26005.1.001-10 BNT extension cable HD, 10 m length
- T26002.1.002-10 TNC extension cable HD, 10 m length
- T2954/K3-10 M extension cable HD, 10 m length

Other lengths, armored versions, versions with BNC and banana pin and 20 m cable on reels upon request.

Build-Up Caps for Ionization Chambers

Brass build-up caps for thimble chambers for use in high-energy photon beams



- ▶ Photon energy ranges from ^{60}Co up to 20 MV
- ▶ Establish electron equilibrium for in-air measurement
- ▶ Suitable for Farmer, Semiflex and PinPoint 3D chambers
- ▶ Made of brass

Build-up caps are used with thimble ionization chambers for in-air measurements in photon beams when electron equilibrium is desired. Each standard delivery of a thimble chamber includes an appropriate acrylic build-up cap for ^{60}Co . Optionally, a variety of build-up caps is available for different ionization chamber types and for different photon energy ranges.

Brass build-up caps are available for the chamber types:

- 0.6 cm³ Farmer chambers
- 0.125 cm³ Semiflex chamber
- PinPoint 3D chamber
- Semiflex 3D chamber

The wall thicknesses cover the energy range from ^{60}Co to 20 MV photons.

Ordering Information

Variety of brass build-up caps upon request

MP1 Phantom Tanks

1D water phantoms for reference dosimetry and measurement of depth dose curves



- ▶ High precision 1D water tanks for reference dosimetry and depth dose measurement of high energy photon and electron beams
- ▶ Comply with the dosimetry protocols AAPM TG-51, IAEA TRS-398 and DIN 6800-2
- ▶ Easy setup with alignment and fill lines and adjustable supports for leveling

The MP1 and MP1 manual water tanks are small 1D phantoms for depth dose measurement to determine beam qualities and measure reference doses according to international dosimetry protocols. The tank sizes meet the AAPM TG51, IAEA TRS 398 and DIN 6800-2 requirements for absorbed dose determinations in reference conditions. The MP1 tank is remote controlled and requires TBA electronics and MEPHYSTO mc² software for operation. Using the MP1 manual tank the detector positions are adjusted by hand. It is equipped with a precise moving mechanism and a digital display of the detector position.

The tanks have vertical moving ranges of 254 mm and external horizontal phantom dimensions of 320 mm x 370 mm. Holding devices to mount semiflex, Farmer and electron chambers to the moving mechanism are available. Each phantom has three adjustable supports for levelling and a collision-protected drain tap for emptying without tilting or changing the phantom's position. Alignment and fill lines ensure an easy setup.

Ordering Information

T41019	MP1 phantom tank
T41025	MP1 manual phantom tank
E41200B/S/G	Service contract Bronze, Silver or Gold

Chamber holding devices upon request

Water Phantom for Vertical Beams

Small size water phantom for reference dosimetry in photon and electron beams with vertical beam incidence



- ▶ Suitable for calibration of ionization chambers in high-energy photon and electron beams
- ▶ Suitable for monitor calibration in water
- ▶ Makes it possible to irradiate a thimble chamber in water with vertical beam incidence
- ▶ Makes it possible to vary the measuring depth by water level adjustment

The water phantom type 41001 is designed for calibration measurements in radiation therapy with vertical beam incidence directly into the water surface. Measurements are done with a horizontally mounted thimble chamber, put into position through a hole in one side wall by using an appropriate waterproof acrylic adapter. To seal the hole, the adapter is supplied with an O-ring. By inserting the adapter tip into a cavity on the opposite wall, which serves as support, the adapter is fixed. Adapters are available for a variety of thimble chambers. The measuring position is 150 mm below the upper edge of the tank. The measuring depth can be varied by height adjustment of the water level by means of a vertical scale on the phantom wall. The external phantom dimensions are approximately 30 cm x 30 cm x 30 cm. The phantom has two handles for easy carrying, three adjustable supports for leveling, etched cross hairs for alignment and a collision protected drain tap for emptying without tilting or changing the phantom's position.

Ordering Information

T41001 Stationary water phantom

Option

Chamber adapters upon request

Water Phantom for Horizontal Beams

Small size water phantom with sliding caliper for reference dosimetry with horizontal beam incidence



- ▶ Suitable for calibration of ionization chambers in high-energy photon and electron beams
- ▶ Suitable for monitor calibration in water
- ▶ Makes it possible to irradiate up to three chambers simultaneously
- ▶ Makes it possible to vary the measuring depth continuously

The water phantom type 41023 is designed for calibration measurements in radiation therapy using a horizontal beam. Up to three ionization chambers (alternatively TL detectors and FeSO_4 ampoules) can simultaneously be placed at different water depths with a distance of 50 mm from chamber axis to chamber axis by using waterproof acrylic adapters. The measuring depth can be adjusted continuously by means of a caliper on the phantom top. Appropriate adapters enable users to position thimble chambers precisely in depths from less than 15 mm up to 260 mm and plane-parallel electron chambers as well as thermoluminescent detectors from 6 mm up to 260 mm. The external phantom dimensions are approximately 30 cm x 30 cm x 30 cm. The entrance window in one of the walls has the thickness of 3 mm and the size of 170 mm x 170 mm. The phantom has two handles for easy carrying, three adjustable supports for leveling, etched cross hairs for alignment and a collision protected drain tap for emptying without tilting or changing the phantom's position.

Ordering Information

T41023 Stationary water phantom

Option

Detector adapters upon request

ESTRO Mini Phantoms

Acrylic phantoms for “in air” measurement acc.
ESTRO recommendation

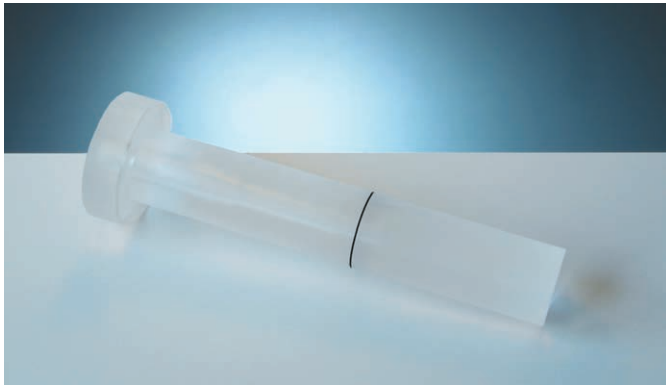

- ▶ “In air” measurement according to ESTRO
- ▶ Accommodate detectors at a depth of 100 mm

The acrylic cylinder mini phantoms are designed for “in air” measurements or the measurement of volume scatter ratios, described in the ESTRO booklet 3/1997. They have a height of 188 mm and a diameter of 40 mm each.

Ordering Information

T40023.1.010	ESTRO Mini Phantom longitudinal for Farmer chamber
T40036.1.010	ESTRO Mini Phantom perpendicular for Farmer chamber
T40036.1.020	ESTRO Mini Phantom perpendicular for 0.3 cm ³ semiflex chamber
T40023.1.020	ESTRO Mini Phantom for microDiamond
T40023.1.030	ESTRO Mini Phantom for Semiflex 3D

Brass Mini Phantoms

Brass phantoms for “in air” measurements

- ▶ “In air” measurement according to standards
- ▶ Accommodate a PinPoint 3D type chamber or different detectors types at a water equivalent depth of 100 mm

The brass mini phantoms are designed for “in air” measurements for small fields with an axial irradiation. Due to a minimum wall thickness they can be used for field sizes down to 1.5 cm.

Ordering Information

T31016.1.300	Brass Mini Phantom for PinPoint 3D chamber
T40064	Brass Mini Phantom for microDiamond

RW3 Slab Phantom

Water-equivalent RW3 slab phantom with chamber adaptation plates for therapy dosimetry

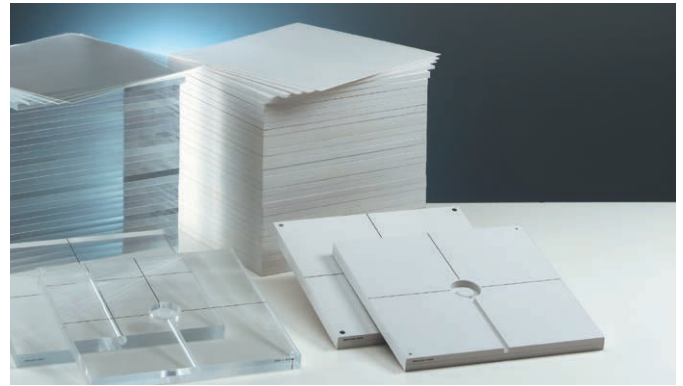

- ▶ Makes it possible to perform monitor calibrations and depth dose measurements in a solid state phantom
- ▶ Suitable for high energy photon and electron dosimetry
- ▶ Makes it possible to vary the measuring depth up to 30 cm in increments of 1 mm
- ▶ Made of water-equivalent RW3 material (Goettingen White Water) with thickness tolerance of ± 0.1 mm

The RW3 phantom is water-equivalent in the energy ranges from ⁶⁰Co to 25 MV photons and from 4 MeV to 25 MeV electrons. The phantom is used for monitor calibration and quality assurance measurements. Depth dose measurements are made by varying the measuring depth. To provide for backscatter, slabs are placed below the radiation detector. The slab phantom consists of 1 plate 1 mm thick, 2 plates each 2 mm thick, 1 plate 5 mm thick and 29 plates each 10 mm thick. This combination makes it possible to vary the measuring depth in increments of 1 mm. The size of the complete phantom is 30 cm x 30 cm x 30 cm. Adapter plates for a number of detector types are available for both phantoms. Each plate is precisely machined for a thickness tolerance of only ± 0.1 mm.

Ordering Information

T29672	Water-equivalent RW3 slab phantom
T2967/12	Carrying case for slab phantom

Option

Detector plates upon request

Radioactive Check Devices

Radioactive check devices for air density correction and constancy checks of therapy doseimeters



- ▶ Perform air density corrections when using vented ionization chambers
- ▶ Check proper functioning and constancy of the complete doseimeter
- ▶ Two types for thimble and flat chambers are available
- ▶ Include encapsulated low activity of 33 MBq (type T48012) resp. 20 MBq ^{90}Sr (type T48010)

The radioactive check devices enable medical physicists to check the stability of ionization chamber response and to determine air density correction factors. Check readings should be done each time before starting a dose measurement. The chamber calibration certificate includes the reference reading under standard conditions. The check reading will decrease over time due to the decay of the activity. Both check devices include shielding containers, and the check device T48012 is supplemented by a thermometer for controlling the check device temperature. Various holding devices for the adaptation of different ion chambers are available. Due to the arrangement of the radioactive source of the check device model T48012, the measuring volume of the inserted thimble chamber is irradiated from all directions. The cylindrical source of the check device model T48010 is placed near to the entrance window of flat ion chambers by means of the appropriate holding device. The source T48012 is equivalent to ISO class C64445, the source T48010 is equivalent to class C6X444. The dose rate in 10 cm distance is below 1 $\mu\text{Sv/h}$ (with cover closed). Please observe the national regulations for transport and use of radioactive material. Before shipping, we need a confirmation certifying that the purchaser is allowed to handle the radioactive sources.

Ordering Information

T48012 Radioactive check device for thimble chambers
T48010 Radioactive check device for flat chambers
Chamber/check source holding devices upon request

Barometer, Thermometer

Precise air pressure and temperature measuring instruments for air density correction of ion chamber readings



- ▶ The barometers provide precise measurement of absolute air pressure in hPa
- ▶ Official calibrations traceable to primary standards are available for barometers and thermometer

The precision barometers and the thermometers are used to determine air density correction factors for reference dosimetry.

Data loggers measure air pressure, temperature and humidity. Data can be downloaded from the data logger. Calibrations according to ISO and according to DAkkS (national accreditation body of Germany) are available.

Ordering Information

L992009 Data Logger 600-1100 hPa testo 176 P1 TPH
L992010 Data Logger 600-1100 hPa testo 176 P1 TPH
incl. DAkkS calibration

Therapy Beam Analysis

▶ BEAMSCAN Water Phantom System	23
▶ BEAMSCAN Software	24
▶ BEAMSCAN MR	25
▶ MP3-XS Phantom Tank	26
▶ MP3-P, MP3-PL Phantom Tanks	26
▶ Bragg Peak Ionization Chambers	27
▶ PEAKFINDER Water Column	27
▶ MP3-T Phantom Tank	28
▶ MP1 Phantom Tanks	28
▶ TRUFIX Detector Positioning	29
▶ T-REF Chamber	29
▶ Film Digitizers for Film Densitometry	30
▶ TBA Trolley	30



BEAMSCAN® Water Phantom

All-in-one 3D water phantom system for automatic dose distribution measurement of radiation therapy beams

- ▶ All built-in design ready for use straight out of the box
- ▶ Fully automated, wireless setup with BEAMSCAN Wizard on any smart device
- ▶ Patented fully automatic virtual tank leveling TRULEVEL™ and auto field alignment
- ▶ Wireless operation and data transfer
- ▶ Fast scanning (up to 20 mm/s) with continuous and step-by-step scanning mode
- ▶ Built-in, high-precision electrometer
- ▶ Easy clip-in detector installation with TRUFIX BS
- ▶ Optimized workflows from scanning to protocol-based documentation

With all electronics and cables directly built into the system, the all-in-one BEAMSCAN is ready for use straight out of the box. No cable runs and there are no external devices to install. Move it into the treatment room, align and position it to the LINAC, plug in the power cable and set the SSD.

BEAMSCAN provides you with a fully automated setup. Its unique, patented virtual auto leveling function ensures that your water tank is properly leveled with the touch of a single button, without physically moving the tank or scanning arm. Simply access the built-in BEAMSCAN web server via WiFi using a mobile device (iPod touch® included). There is no need to install or connect data cables to use BEAMSCAN. It can also be connected to a LAN socket if desired.

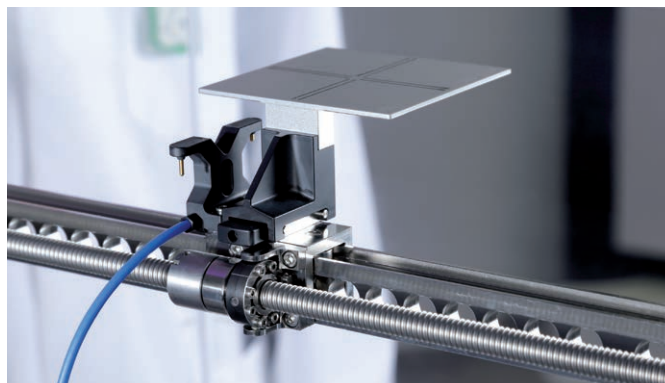

With enhanced mechanics and a new built-in state-of-the-art electrometer, BEAMSCAN lets you scan profiles with a scanning speed of up to 20 mm/s within a scanning range of 50 x 50 x 41.5 cm³. The detector mounting is easily performed with the patented TRUFIX BS clip-in detector mounting and positioning system, including the "click-fix" SSD adjustment tool. The delivery includes two 0.07 cm³ Semiflex 3D ionization chambers.

BEAMSCAN comes with a powerful, feature-rich software that makes it easy for you to collect and analyze your beam data the way you need it. Select from ready-to-use, TPS-specific task lists and perform multiple measurement tasks in one go. Export your data to the optional Track-it QA database to track machine performance.

Ordering Information

L981474	BEAMSCAN Water Phantom, complete, M connector, incl. BEAMSCAN software
L981475	BEAMSCAN Water Phantom, complete, BNT connector, incl. BEAMSCAN software
L981476	BEAMSCAN Water Phantom, complete; TNC connector, incl. BEAMSCAN software
S080054.002	Option Reference Dosimetry
E41200B/S/G	Service contract Bronze, Silver or Gold

BEAMSCAN® Software

Software for beam data acquisition and analysis with BEAMSCAN water phantoms

- ▶ Advanced data processing based on Artificial Intelligence
- ▶ Wireless Auto Setup for fast and easy phantom setup
- ▶ TPS-specific, customizable task lists for automatic beam data collection
- ▶ Advanced measurement options, e.g., TPR/TMR, output factors, absolute dose, large profiles
- ▶ Real-time display of beam profiles for beam steering measurements
- ▶ Enhanced data processing and analysis tools, including profile comparisons, FFF analysis, reference/film dosimetry
- ▶ Fully integrated with Track-it

BEAMSCAN software is a feature-rich, user-friendly software platform for fast, efficient beam data acquisition and analysis. Fully integrated with Track-it, it provides a complete solution from scanning to protocol-based documentation.

Designed with the user in mind, BEAMSCAN software facilitates commissioning and QA tasks. Its Wireless Auto Setup reduces phantom setup time to a minimum. TPS-specific tasks lists are already included and can be easily customized to automate beam data acquisition. All treatment machines and detectors can be accessed and managed effectively from one single location. A wide range of measurement options is selectable to perform all necessary measurements with one single platform, including SSD conversion for large profile measurements, TPR/TMR, output factors for any field size or geometry, wedge/tray factors, isodose distributions in different depths or absolute dose. Reference curves can be overlaid on running measurements for convenient online comparison. Beam profiles can be easily displayed in real-time to allow beam steering measurements.

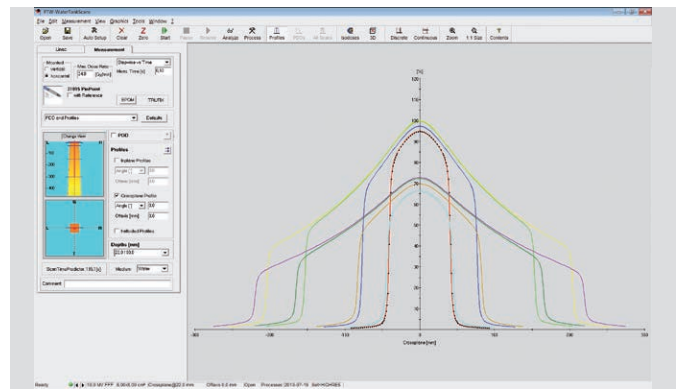

Powerful data processing and expert analysis tools help to better visualize and analyze the acquired beam data. Users can choose from a variety of mathematical functions and filters, including smoothing, averaging, mirroring or shifting profiles, correcting the CAX of FFF profiles or converting measured ionization curves to absorbed dose water curves based on international protocols or user defined R_{50} . FFF beam profiles are automatically detected and evaluated following recommendations of Fogliata et al. The acquired beam data can be quickly analyzed according to international or vendor-specific protocols. A table generator makes it easy for users to automatically calculate TPR/TMR, OCR and output factors.

With interfaces to all treatment planning systems, BEAMSCAN software makes it easy to correctly format analyzed beam data for import into the treatment planning system.

Ordering Information

BEAMSCAN software is part of the BEAMSCAN system

Options

- S080054.002 Option Reference Dosimetry for BEAMSCAN
- S080054.001 Option Film Analysis for BEAMSCAN
- S080054.003 Option Planning Module for BEAMSCAN (type of RTPS to be specified)

BEAMSCAN® MR

All-in-one 3D water phantom system for automatic dose distribution measurement in MR environments

- ▶ Integrated, fully equipped solution
- ▶ All-in-one system for fast, hassle-free setup
- ▶ Vendor-specific water tanks with optimized scanning ranges
- ▶ Fast scanning up to 30 mm/s
- ▶ Built-in, high-precision electrometer
- ▶ Patented TRUFIX system for quick axial and radial detector setup

BEAMSCAN MR is a complete solution for commissioning and QA of MR-LINACs – from automatic beam data acquisition, processing and analysis to protocol-based documentation. Built to the highest quality and technology standards, BEAMSCAN MR is exceptionally robust, incredibly versatile and straightforward in its operation. As an all-built-in system, it comes ready to use on a single carriage, including everything needed. A comfortable touch panel guides you step by step through the installation and setup process.

The system is dedicated for use with MR-LINACs up to 1.5 T. Two models with vendor-specific water tanks for optimized scanning ranges are available:

568 mm x 145 mm x 355 mm for Elekta Unity and
408 mm x 248 mm x 355 mm for ViewRay® MRIdian®.

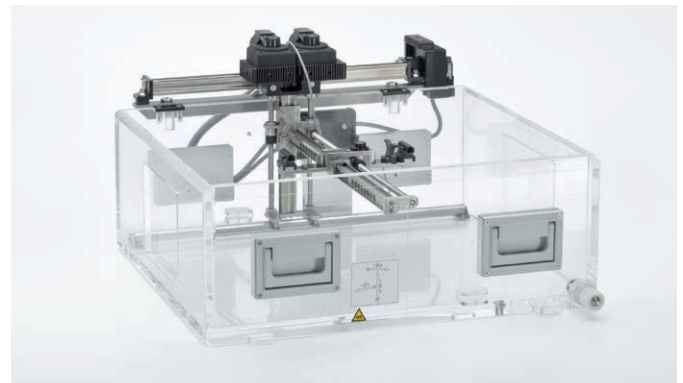

The system includes a built-in fast, sensitive electrometer with excellent signal-to-noise-ratio. It provides a consistent detector orientation for all scans, including off-axis scans. The delivery includes two 0.07 cm³ Semiflex 3D ionization chambers.

BEAMSCAN MR comes with a powerful, feature-rich software that makes it easy for you to collect and analyze your beam data the way you need it. Select from ready-to-use, TPS-specific task lists and perform multiple measurement tasks in one go. Export your data to the optional Track-it QA database to track machine performance.

Ordering Information

L981558	BEAMSCAN MR Water Phantom for Elekta, complete, incl. BEAMSCAN software
L981559	BEAMSCAN MR Water Phantom for Viewray®, complete, incl. BEAMSCAN software
E41210B/S/G	Service contract Bronze, Silver or Gold

Pending 510(k), not available for sale within the United States

MP3-XS Phantom Tank

Small size motorized 3D water phantom for automatic dose distribution measurement of radiation therapy beams



- ▶ High precision small volume 3D water tank for stereotactic or IORT dose distribution measurements
- ▶ 3D stainless steel moving mechanism with high speed stepper motors

The MP3-XS water tank is a small 3D phantom for remote-controlled dose distribution measurements of small radiation fields as used for example in stereotaxy or intra-operation radiation therapy IORT. The horizontal moving range is 200 mm x 200 mm and the vertical range is 300 mm. The phantom has three adjustable supports for leveling, etched crosshairs for alignment and a collision protected drain tap for emptying without tilting or changing the phantom's position. The 20 mm thick acrylic walls and bottom do not bulge during prolonged period of use. Precision stepper motors are mounted close above the tank making it possible to adjust distances between the LINAC head and the water surface as small as 120 mm. They provide for high detector moving speed of 50 mm/s and high positioning accuracy of ± 0.1 mm. In contrast to analog drives, stepper motor drives do not require regular recalibrations. Stainless steel drive mechanics are used to minimize water perturbation and to preserve positioning accuracy during movement. They do not disturb or affect the measurement accuracy.

Ordering Information

L981172 MP3-XS Water Phantom, complete, BNT connector
 L981173 MP3-XS Water Phantom, complete, TNC connector
 L981174 MP3-XS Water Phantom, complete, M connector
 L981648 MP3-XS Water Phantom, complete for ZAP, BNT connector
 L981649 MP3-XS Water Phantom, complete for ZAP, TNC connector
 L981650 MP3-XS Water Phantom, complete for ZAP, M connector
 E41200B/S/G Service contract Bronze, Silver or Gold

MP3-P Phantom Tank

Motorized 3D water phantom for horizontal radiation therapy beams for protons and heavy ions



- ▶ High precision 3D water tank for proton and heavy ion therapy
- ▶ Size and moving range optimized for horizontal beam
- ▶ Thin entry window for highest precision

The MP3-P water tank is a 3D phantom for remote controlled scans with 100 μm increments to determine the Bragg peak position of proton and heavy ion beams. The scanning range is 350 mm x 250 mm horizontally and 380 mm vertically. A thin exchangeable entrance window of 250 mm x 250 mm x 5 mm PMMA makes the system suitable for horizontal beams with highest precision measurements. Dual chamber holders allow the fixation of Bragg peak chambers to the MP3-P. One chamber is mounted to the entrance window outside of the water tank, the second chamber is mounted to the moving mechanism for relative dose measurements. To operate the tank, MEPHYSTO mc^2 software and TBA electronics are required.

Alternatively a larger variant of the MP3-P, the MP3-PL is available as well. The scanning range with this phantom is 490 mm x 400 mm x 490 mm.

Ordering Information

L981403 MP3-P Water Phantom, connecting system M including SCANLIFT
 L981526 MP3-PL Water Phantom, connecting system M including SCANLIFT
 L981423 Dual chamber holder for fixation of two Bragg peak chambers to the tank. Chamber type 34070 or 34080 as reference and chamber type 34070 measures depth dose distributions
 E41200B/S/G Service contract Bronze, Silver or Gold

Bragg Peak® Ionization Chambers

Waterproof plane-parallel chambers for dosimetry in proton and heavy ion beams



- ▶ Waterproof, wide guard ring design
- ▶ Sensitive volumes 34 cm³ and 10.5 cm³, vented to air

The Bragg peak chambers are designed to measure the exact location of the Bragg peak in therapy proton and heavy ion beams. The large diameters of the chambers allow the measurement of the complete beam diameter (non-scanned) including the scattered particles. The chambers are waterproof and consequently can either be used in air behind a water column or in a water phantom.

In water, the Bragg peak chambers can be used for measurements of horizontal beams. Due to the thick entrance and exit windows, the 34070 and 34089 Bragg peak chambers can also be used in vertical beams where measurements are performed in different water depths.

Ordering Information

Bragg peak chambers, connecting system BNT, TNC or M:

34089	Bragg Peak 150 chamber 34 cm ³ , cable length 2.5 m
34070-2,5	Bragg Peak chamber 10.5 cm ³ , cable length 2.5 m
E41150B/S/G	Service contract Bronze, Silver or Gold

PEAKFINDER Water Column

Water column system for highest precision peak detection in proton and heavy ion therapy



- ▶ Measures position of Bragg peak within (20 ... 350) mm with a spatial resolution of 10 µm
- ▶ Built-in monitor and measuring chambers
- ▶ Gate input for spill-by-spill measurements

The PEAKFINDER water column is especially designed for highest precision peak detection of proton and heavy ion beams in particle therapy. It is a closed water column for scans up to 35 cm depth with increments of 10 µm. Because of its sealed construction it can be used in any spatial orientation. Windows allow a visible inspection of the column inside. The signals of the built-in thin window Bragg peak chamber T34080 and the monitor chamber T34082 are read out by the TANDEM XDR elec-trometer. A TCP/IP interface is implemented for software control.

The PeakScan software package allows precise measurements and a detailed Bragg peak analysis.

Ordering Information

L981257	PEAKFINDER water column, including electronics, dosimeter, measurement and reference chamber
S080052	PeakScan software
T41049	PEAKFINDER holder 180°
L981441	PEAKFINDER holder 0-90°
E41250B/S/G	Service contract Bronze, Silver or Gold

MP3-T Phantom Tank

3D water phantom for automatic dose distribution measurement at TomoTherapy® treatment units



- ▶ High precision 3D water tank
- ▶ Size, moving range and motor positions optimized for TomoTherapy® Hi·Art® Systems
- ▶ 3D stainless steel moving mechanism with high speed stepper motors

The MP3-T water tank is optimized for the use with TomoTherapy® Hi·Art® treatment units with dynamic arc techniques. Once adjusted to the therapy unit, the water tank has not to be moved to cover all measuring tasks. The 20 mm thick acrylic walls do not bulge during prolonged period of use and feature etched lines for precise tank alignment. Precision stepper motors are mounted on a position for the use in the TomoTherapy® Hi·Art® gantry. They provide for high detector moving speed of 50 mm/s and high positioning accuracy of ± 0.1 mm. In contrast to analog drives, stepper motor drives do not require regular recalibrations.

To operate the tank, BEAMSCAN software and TBA electronics are required.

TomoTherapy and Hi·Art are registered trademarks of TomoTherapy Incorporated

Ordering Information

T41026.1.001 MP3-T Acrylic water tank
T41026.1.100 MP3-T Semiflex chamber holding device

MP3-T water phantom sets including dosimeter, chamber, cables and software BEAMSCAN:

L981199 MP3-T Water phantom, connecting system BNT
L981183 MP3-T Water phantom, connecting system TNC
L981182 MP3-T Water phantom, connecting system M
E41200B/S/G Service contract Bronze, Silver or Gold

MP1 Phantom Tanks

1D water phantoms for reference dosimetry and measurement of depth dose curves

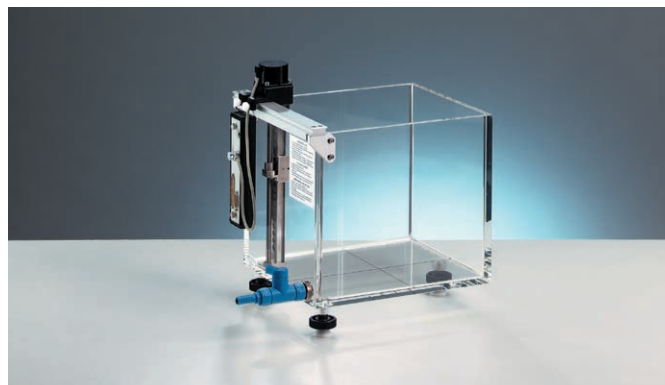

- ▶ High precision 1D water tanks for reference dosimetry and depth dose measurement of high energy photon and electron beams
- ▶ Comply with the dosimetry protocols AAPM TG-51, IAEA TRS-398 and DIN 6800-2
- ▶ Easy setup with alignment and fill lines and adjustable supports for leveling

The MP1 and MP1 manual water tanks are small 1D phantoms for depth dose measurement to determine beam qualities and measure absolute doses according to international dosimetry protocols. The tank sizes meet the AAPM TG51, IAEA TRS 398 and DIN 6800-2 requirements for absorbed dose determinations in reference conditions. The MP1 tank is remote controlled and requires TBA electronics and MEPHYSTO mc² software for operation. Using the MP1 manual tank the detector positions are adjusted by hand. It is equipped with a precise moving mechanism and a digital display of the detector position.

The tanks have vertical moving ranges of 254 mm and external horizontal phantom dimensions of 320 mm x 370 mm. Holding devices to mount semiflex, Farmer and electron chambers to the moving mechanism are available. Each phantom has three adjustable supports for levelling and a collision-protected drain tap for emptying without tilting or changing the phantom's position. Alignment and fill lines ensure an easy setup.

Ordering Information

T41019 MP1 phantom tank
T41025 MP1 manual phantom tank
E41200B/S/G Service contract Bronze, Silver or Gold
Chamber holding devices upon request

TRUFIX® Detector Positioning

Positions the effective point of measurement of different therapy detectors exactly to the water surface in TBA systems



- ▶ Positioning of effective points of measurement of detectors on the water surface
- ▶ Interchangeability of various detector types without resetting the effective points of measurement
- ▶ Can also be used for horizontal irradiation
- ▶ Maintains minimum distance to the metal parts of the moving mechanism

The TRUFIX precision attachment system is used for simple installation of various ionization chambers and detectors in TBA systems. It serves for fast and precise positioning of effective points of measurement of various detectors on the water surface in water phantoms.

Ordering Information

L981150 TRUFIX Basic equipment
Holders for various detectors upon request

T-REF Chamber

Reference detector for small fields



- ▶ Very low total area density of 206 mg/cm²
- ▶ No measurable perturbation of the beam
- ▶ High and very stable signal
- ▶ No contact to linac head
- ▶ Fast and easy to mount

The T-REF chamber 34091 provides a solution to the problem where to put a reference detector in small fields. The T-REF chamber is a large-area plane-parallel transmission reference chamber and proved to be easy to use. From the minimum distance to the water surface on, there are no measurable perturbations of the beam. The very good signal-to-noise-ratio makes it an excellent option for the use as a reference detector.

Ordering Information

TN34091	T-REF chamber, connecting system BNT including holder
TW34091	T-REF chamber, connecting system TNC including holder
TM34091	T-REF chamber, connecting system M including holder
E41150B/S/G	Service contract Bronze, Silver or Gold

Film Digitizers for Film Densitometry

Film Scanners for digitizing radiographic films irradiated for film dosimetry in radiotherapy



- ▶ Computer controlled 48 bit (16 bit) scanners to digitize radiographic films
- ▶ Dynamic measuring ranges of up to 4.0 optical density
- ▶ Support TWAIN Interface

The VIDAR DosimetryPro Advantage (Red)

16 bit HD-CCD scanner, measuring range (0 ... 4.0) OD. For the use of GAFCHROMIC® EBT and X-ray films (20 ... 35.6) cm width, and (20 ... 43.2) cm length, resolution max. 89 µm. Universal power supply (85 ... 264) V, (47 ... 63) Hz.

The EPSON Expression 11000XL Pro

A3 flatbed color scanner (RGB 48 bit) for the use of GAFCHROMIC® EBT films. Resolution 2400 dpi, measuring range max 3.8 OD, USB 2.0 computer interface, includes transmission light unit and universal power supply (110 ... 120) V, (220 ... 240) V, (50 ... 60) Hz.

All above mentioned types of scanners can be operated by computer control, using USB interface and TWAIN drivers with the FilmSoft or VeriSoft software packages or the Film-Analysis option in MEPHYSTO mc² for dosimetry evaluation.

Ordering Information

Detailed information on film digitizers upon request

TBA Trolley

Trolley with three plane storage space for TBA electronics, computer and peripheral devices



- ▶ Accommodates electronic water phantom components for mobile use
- ▶ Includes three storage planes
- ▶ Includes a multi-way grounding type mains plug

The TBA trolley has three planes to store the electronic devices including the computer and peripheral devices such as a printer. Four wheels make it possible to move the electronic components to different control rooms of radiotherapy treatment units. The electronic components can be powered by a switchable multi-way mains plug.

Ordering Information

L656004 Trolley

Quality Control

▶ RUBY Phantom	33
▶ OCTAVIUS 4D	35
▶ OCTAVIUS I, 1500	36
▶ OCTAVIUS I, 1500 MR	36
▶ OCTAVIUS I, 1000 SRS	37
▶ OCTAVIUS I, 1600 SRS	37
▶ OCTAVIUS II, 1500	38
▶ OCTAVIUS Detector 1500 XDR	38
▶ OCTAVIUS Detector 1600 XDR	39
▶ OCTAVIUS Accessories	39
▶ VERIQA	40
▶ VeriSoft Verification Software	41
▶ Track-it Software	41
▶ QUICKCHECK weblin Test Device	42
▶ STARCHECK 2D Chamber Array	42
▶ STARCHECK maxi Chamber Array	43
▶ STARCHECK maxi MR Chamber Array	43
▶ BQ-CHECK Test Object	44
▶ FIELDCHECK	44
▶ MultiCheck LINAC QC Software	45
▶ EPID QC PHANTOM	45
▶ epidSoft Software	46
▶ IGRT QC Set	46
▶ ISOCHECK Isocenter Test Device	47
▶ IsoCheck epid Software	47
▶ SC Holding Device	48
▶ SOURCECHECK 4 π	48

Quality Control

Regular quality control procedures are mandatory to secure patient radiation treatment on high quality levels. Since quality checks have to be done quite frequently by the responsible medical physics staff, the PTW test tools are designed for time-saving, accurate results with easy handling and minimum loss of treatment unit operation time.

The quality test devices enable the responsible medical physics experts to comply with international standards.

The following quality control tasks can be fulfilled with the equipment presented in this chapter:

- ▶ IMRT verification
 - OCTAVIUS systems
 - VeriSoft IMRT dose verification software

- ▶ Daily LINAC performance test
 - OCTAVIUS Detectors
 - STARCHECK 2D Ion chamber array
 - QUICKCHECK weblin
 - BQ-CHECK beam quality test object

- ▶ Geometric beam test
 - FIELDCHECK congruence of light and radiation field test device
 - ISOCHECK isocenter test device

- ▶ Universal holding device for measuring equipment
 - SC holding device for LINAC gantry mount

- ▶ EPID quality control
 - EPID QC phantom

RUBY Phantom

Modular phantom for System QA, LINAC QA and Patient QA

- ▶ Modular phantom platform with powerful, ready-to-use application-specific inserts
- ▶ Comprehensive end-to-end testing of the entire process with one single insert
- ▶ Systematic QA of multiple metastases treatments with one isocenter
- ▶ Alignment checks of the entire system, including 6D couches and SGRT systems
- ▶ CT markers in phantom and all inserts for enhanced visibility
- ▶ Integrated, compatible solution – phantom, inserts, detectors from one single source

RUBY is a new modular phantom platform for radiotherapy QA. With its unique modular phantom design and variety of application-specific inserts, RUBY combines versatility with unrivaled flexibility. It allows to perform integrated tests of the entire treatment chain with one basic phantom by adding and expanding QA capabilities as and when needed.

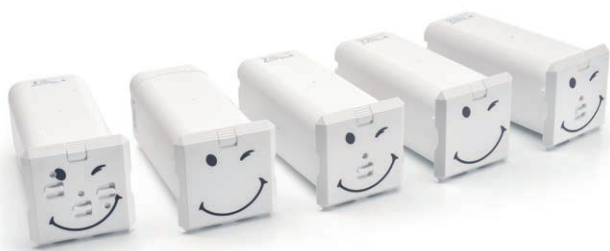

RUBY is compatible to Semiflex, Semiflex 3D, PinPoint 3D, microSilicon and microDiamond detector. Easy, fast and accurate detector positioning is done with detector-specific detector holders.

An increasing number of special stereotactic radiations are performed with couch extensions equipped with head shells. Under these settings, the QA equipment must be positioned within the head shell for the quality assurance of these systems. For this type of application, the RUBY system can be combined with the RUBY head phantom. The RUBY head phantom is compatible with all inserts.



The treatment of multiple metastases with one isocenter is getting increasing clinical relevance. These non-isocentric treatment techniques require additional quality assurance. The System QA MultiMet insert is dedicated to the systematic QA of these irradiation techniques, with or without couch rotation.



System QA Set L981636 with RUBY base phantom

Comprehensive end-to-end testing of the entire process with the RUBY System QA insert

- ICRU-based tissue-equivalent materials (brain, lung and bone) for electron density check, TPS contouring QA and enhanced visibility in kV, CBCT and MV images
- MRI visible cavities enable check of CT/MRI registration and qualitative MRI distortion check
- Detector positioning at the center of the insert marked with CT markers made of bone equivalent material

Systematic QA of multiple metastases treatments with one isocenter with RUBY System QA MultiMet insert

- Enables positioning of three detectors at different positions within the insert marked with CT markers made of bone equivalent material
- Contains three cylinders made of bone equivalent material for enhanced visibility in kV, CBCT and MV images
- Enables systematic QA of multi metastases treatments, e.g. Varian HyperArc™



LINAC QA Set L981637 with RUBY base phantom

- Daily checks of IGRT positioning accuracy, including 6D couches and SGRT systems with RUBY Linac QA insert
- Tissue-equivalent bone structures for enhanced visibility in kV, CBCT and MV images
 - High-density radiopaque sphere at isocenter for easy Winston-Lutz testing (Automated analysis of MV images with optional IsoCheck epid software)
 - Clearly visible markings for defined translational and rotational displacement

Patient QA Set L981638 with RUBY base phantom

- RUBY Patient QA Detector insert for fast, accurate single-point dose measurements
- Homogenous insert with easy, fast and accurate detector positioning

RUBY Patient QA Film insert for precise radiochromic film measurement

- Homogenous insert for film positioning of radiochromic film

RUBY Set MultiMet L981654 with RUBY head phantom

- Set for comprehensive testing of multiple metastases treatments with one isocenter and use of head shells RUBY head phantom
- Homogenous head shaped phantom with marking for translational displacement; compatible to patient mask systems

Systematic QA of multiple metastases treatments with one isocenter with RUBY System QA MultiMet insert

- enables positioning of three detectors at different positions within the insert marked with CT markers made of bone equivalent material
- Contains three cylinders made of bone equivalent material for enhanced visibility in kV, CBCT and MV images
- Enables systematic QA of multi metastases treatments, e.g. Varian HyperArc™

Ordering Information

RUBY Sets

- L981636 RUBY System QA Set
- L981637 RUBY Linac QA Set
- L981638 RUBY Patient QA Set
- L981654 RUBY Head Phantom Set MultiMet
- L981660 RUBY All in Set

Individual Ordering

- T40072.1.001 RUBY base phantom
- T40072.1.800 RUBY head phantom
- T40072.1.100 RUBY Patient QA detector insert
- T40072.1.200 RUBY Linac QA insert
- T40072.1.300 RUBY System QA insert
- T40072.1.400 RUBY Patient QA film insert
- T40072.1.500 RUBY insert System QA – MultiMet
- T40072.1.030 RUBY tilted base

Single detector holders upon request



OCTAVIUS 4D



4D Patient Plan Verification

- ▶ True independent 4D dose verification
- ▶ Dose measurements inside the entire phantom volume
- ▶ Unique rotating phantom offering perfect isotropic measurement geometry
- ▶ Modular phantom with exchangeable tops
- ▶ Superior ionization chamber technology
- ▶ Phantom suitable for different detector arrays
- ▶ Suitable for FFF LINACs
- ▶ Failed point analysis in patient contours
- ▶ DVH analysis option

OCTAVIUS 4D is a 4D dosimetry system designed to verify IMRT treatment plans based on true independent measurements. It rotates with the gantry, measuring the dose inside the entire phantom volume, always perpendicular to the incident beam. As a consequence, OCTAVIUS 4D requires no angular corrections or detector calibrations to compensate for the directional response of its detectors which makes it perfectly suited for rotational delivery techniques and easy-to-use in clinical routine. The modular phantom can be adapted for SRS treatment or LINAC QA.

With its powerful acquisition and 3D dose analysis capabilities the software VeriSoft allows to compare the dose in transverse, coronal and sagittal planes and to analyze the measurement results superimposed on the patient's CT scan. VeriSoft allows to perform a volume analysis comparing the measured dose against the calculated dose for the entire phantom volume.

The optional software module DVH 4D calculates dose-volume histograms (DVHs) for each structure in less than a few minutes and compares them with the DVHs calculated by the treatment planning system (TPS). As a truly independent plan evaluation tool, DVH 4D requires no dose data from the TPS, but performs its calculations based entirely on patient CT data and OCTAVIUS 4D measurements, using a unique algorithm.

Supported PTW Detector Arrays:

- ▶ OCTAVIUS Detector 729
- ▶ OCTAVIUS Detector 1500
- ▶ OCTAVIUS Detector 1500 MR
- ▶ OCTAVIUS Detector 1000 SRS
- ▶ OCTAVIUS Detector 1600 SRS

Ordering Information

- L981438 OCTAVIUS 4D system incl. trolley, 1500
- L981429 OCTAVIUS 4D system incl. trolley, 1000 SRS
- L981626 OCTAVIUS 4D system incl. trolley, 1600 SRS

Upgrade Packages for use with existing PTW detector arrays are available

- L981570 OCTAVIUS 4D for Halcyon system incl. trolley, 1500
- L981561 OCTAVIUS 4D MR system for Elekta
- L981562 OCTAVIUS 4D MR system for Viewray

Options

- S070009.001 DVH 4D module
- T40056.1.007 Phantom Insert Plate Semiflex 3D 0.07 cm²
- T40056.1.002 Phantom Insert Plate Semiflex 0.125 cm²
- T40056.1.003 Phantom Insert Plate Farmer
- T40056.1.006 Phantom Insert Plate PinPoint 3D
- T40063.1.004 Standard Top
- T40063.1.002 SRS Top
- T40063.1.003 LINAC QA Top
- E41300B/S/G Service contract Bronze, Silver or Gold

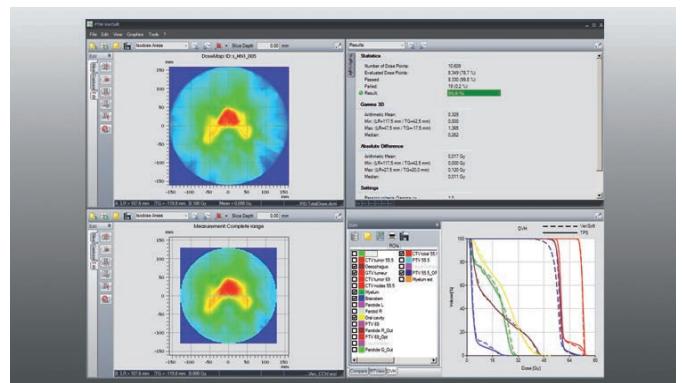

OCTAVIUS I, 1500

IMRT patient plan verification and LINAC QA

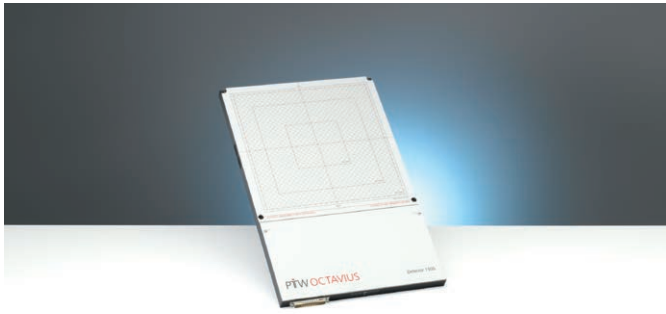

- ▶ Provides a matrix of 1405 detectors resulting in an effective measuring field of 27 cm x 27 cm
- ▶ Diagonal detector spacing of 7.1 mm
- ▶ Best available field coverage of 50 %
- ▶ Avoids detector ageing effects by utilizing ion chambers
- ▶ Gold Standard ionization chamber technology
- ▶ Absolute dose calibration at ^{60}Co
- ▶ One detector – multiple applications
- ▶ Suitable for FFF LINACs

The OCTAVIUS Detector 1500 is a new concept of an ion chamber matrix in a plane for IMRT verification and quality control in radiation therapy. Utilizing ion chambers avoids radiation defects, the major drawback of solid state detectors. The vented plane-parallel ion chambers are 4.4 mm x 4.4 mm x 3 mm in size, and the center-to-center spacing is 7.1 mm. In total there are located 1405 ion chambers in a chessboard matrix, providing a maximum field size of 27 cm x 27 cm. The square chamber design offers unique 50 % field coverage. The OCTAVIUS Detector 1500 can be used for IMRT plan verification, LINAC QC (with optional MultiCheck software) and online LINAC adjustment (with BeamAdjust software). The OCTAVIUS Detector 1500 can be mounted to the gantry using the Universal Gantry Mount, used together with the octagonal OCTAVIUS phantom or with the OCTAVIUS rotation unit for advanced 3D dosimetry.

Ordering Information

L981449	OCTAVIUS I, 1500 incl. electronics and VeriSoft software
E41320B/S/G	Service contract Bronze, Silver or Gold

OCTAVIUS I, 1500 MR

IMRT patient plan verification, LINAC QA and MR-RT QA

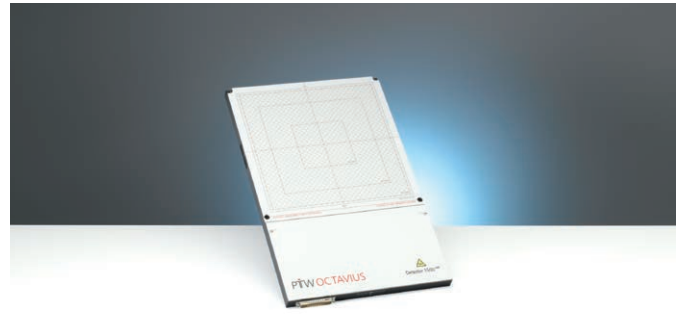

- ▶ Safe for use in high magnetic fields (≤ 1.5 T)
- ▶ Provides a matrix of 1405 detectors resulting in an effective measuring field of 27 cm x 27 cm
- ▶ Diagonal detector spacing of 7.1 mm
- ▶ Best available field coverage of 50 %
- ▶ Avoids detector ageing effects by utilizing ion chambers

The OCTAVIUS Detector 1500 MR is a new concept of an ion chamber matrix in a plane for IMRT verification and quality control in radiation therapy. Utilizing ion chambers avoids radiation defects, the major drawback of solid-state detectors. The vented plane-parallel ion chambers are 4.4 mm x 4.4 mm x 3 mm in size, and the center-to-center spacing is 7.1 mm. In total there are located 1405 ion chambers in a chessboard matrix, providing a maximum field size of 27 cm x 27 cm. The square chamber design offers unique 50 % field coverage. The OCTAVIUS Detector 1500 MR can be used for the dose verification of IMRT beams by using the VeriSoft software, and it can be used for routine quality control of high-energy photon and electron beams by using the MultiCheck software. MLC leaf positioning can also be checked by the OCTAVIUS Detector 1500 MR. This device can be operated safely in high magnetic fields (≤ 1.5 T). It can therefore be used with integrated MRI-radiation therapy machines.

Ordering Information

L981489	OCTAVIUS Detector 1500 MR incl. electronics and data acquisition software BeamAdjust
E41320B/S/G	Service contract Bronze, Silver or Gold

Options

S070009	VeriSoft software
S070011	MultiCheck software

OCTAVIUS I, 1000 SRS

IMRT patient plan verification and LINAC QA for small fields

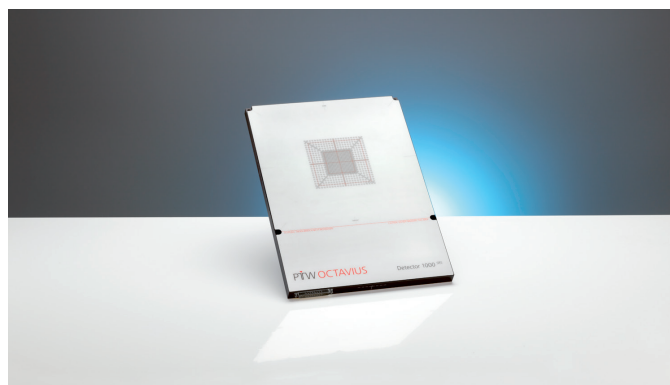

- ▶ 977 liquid filled ionisation chambers¹
- ▶ Detector size 2.3 mm x 2.3 mm x 0.5 mm
- ▶ Detector spacing 2.5 mm (center area)
- ▶ Maximum field size 11 cm x 11 cm
- ▶ Best available field coverage
- ▶ Suited for very small fields

The OCTAVIUS Detector 1000 SRS is the first liquid-filled 2D ionization chamber array. The very small detector size of only 2.3 mm x 2.3 mm x 0.5 mm makes this array ideal suited for dosimetry of small fields. Target application is patient plan verification in stereotactic radio surgery and quality assurance of small fields. In the inner area of 5.5 cm x 5.5 cm the detector distance is 2.5 mm center-to-center, in the outer area of 11 cm x 11 cm the detector distance is 5 mm center-to-center. On the main axes the detector distance is 2.5 mm, on the diagonals 3.5 mm. The excellent surface coverage of the liquid-filled ionization chambers ensures a virtually complete field coverage which otherwise can be obtained by film only. The OCTAVIUS Detector 1000 SRS can be used in a slab phantom or the OCTAVIUS Rotation Unit. It is compatible with the PTW software.

Ordering Information

L981465	OCTAVIUS I, 1000 SRS incl. electronics and VeriSoft software
---------	--

Options

L981324	OCTAVIUS Rotation Unit
L981023	SC Gantry Holding Device
S070011	MultiCheck Software
S080032	BeamAdjust Software
E41320B/S/G	Service contract Bronze, Silver or Gold

OCTAVIUS I, 1600 SRS

IMRT patient plan verification and LINAC QA for small fields

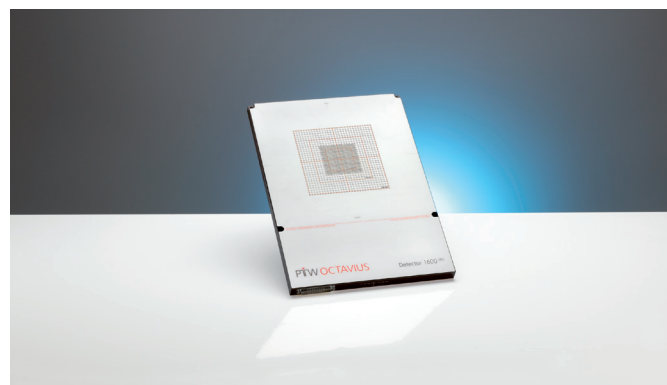

- ▶ 1521 liquid filled ionisation chambers¹
- ▶ Detector size 2.3 mm x 2.3 mm x 0.5 mm
- ▶ Detector spacing 2.5 mm (center area)
- ▶ Maximum field size 15 cm x 15 cm
- ▶ Best available field coverage
- ▶ Suited for very small fields

The OCTAVIUS Detector 1600 SRS is a liquid-filled 2D ionization chamber array. The very small detector size of only 2.3 mm x 2.3 mm x 0.5 mm makes this array ideal suited for dosimetry of small fields. Target application is patient plan verification in stereotactic radio surgery and quality assurance of small fields. In the inner area of 6.5 cm x 6.5 cm the detector distance is 2.5 mm center-to-center, in the outer area of 15 cm x 15 cm the detector distance is 5 mm center-to-center. On the main axes the detector distance is 2.5 mm, on the diagonals 3.5 mm. The excellent surface coverage of the liquid-filled ionization chambers ensures a virtually complete field coverage which otherwise can be obtained by film only. The OCTAVIUS Detector 1600 SRS can be used in a slab phantom or the OCTAVIUS Rotation Unit. It is compatible with the PTW software.

Ordering Information

L981627	OCTAVIUS I, 1600 SRS incl. electronics and VeriSoft software
---------	--

Options

L981324	OCTAVIUS Rotation Unit
L981023	SC Gantry Holding Device
S080032	BeamAdjust Software
E41320B/S/G	Service contract Bronze, Silver or Gold

¹ Due to the specific characteristics of liquid-filled ionization chambers, the values of up to ten individual detectors outside the inner 5 cm x 5 cm area may be deactivated during calibration. Their values are determined by interpolation of surrounding chambers.

¹ Due to the specific characteristics of liquid-filled ionization chambers, the values of up to ten individual detectors outside the inner 6.5 cm x 6.5 cm area may be deactivated during calibration. Their values are determined by interpolation of surrounding chambers.

OCTAVIUS II, 1500

IMAT patient plan verification and
LINAC QA



- ▶ Unique chamber and phantom geometry
- ▶ Superior directional response at different gantry angles without gantry angle corrections
- ▶ Flexible positioning for measurements in the clinically relevant direction and PTV
- ▶ Pioneering ionization chamber technology
- ▶ Ready for measurement (^{60}Co calibrated), no commissioning required
- ▶ Complete field coverage with VeriSoft Merge
- ▶ Improved angular response during irradiation at different gantry angles due to built-in semicircular air cavity and advanced cubic detector design
- ▶ No gantry angle input, angular corrections and cable connections to LINAC required

Including the complete functionality of the OCTAVIUS I, OCTAVIUS II adds a specially designed phantom along with dedicated tools to enable fast and precise verification of composite IMRT plans or IMAT plans.

OCTAVIUS II contains the OCTAVIUS Detector 1500, VeriSoft software and a dedicated OCTAVIUS phantom.

The OCTAVIUS Phantom was designed by Ann van Esch and Dominique P. Huyskens from 7Sigma, Belgium.

Ordering Information

L981450 OCTAVIUS II, 1500
E41320B/S/G Service contract Bronze, Silver or Gold

OCTAVIUS Detector 1500 XDR

Patient plan verification and quality
assurance for proton and heavy ion
beams

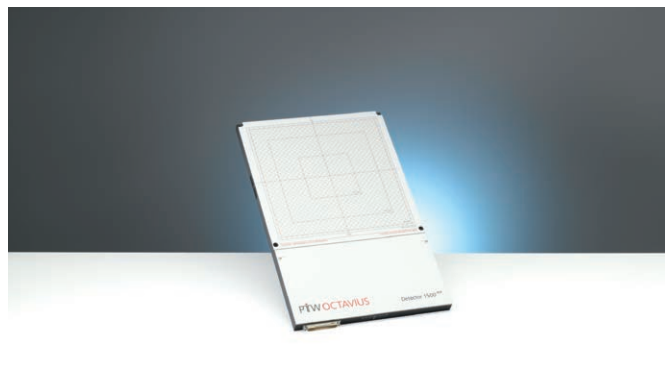

- ▶ Outstanding detector and matrix design
- ▶ 1405 vented cubic ion chambers, uniformly arranged on a 27 cm x 27 cm matrix
- ▶ Pioneering ionization chamber array, flat and lightweight (6 kg)
- ▶ Gold Standard ionization chamber technology
- ▶ Absolute dose calibration at ^{60}Co
- ▶ One detector – multiple applications
- ▶ Suitable for proton and heavy ion beams

The OCTAVIUS Detector 1500 XDR is a new concept of an ion chamber matrix in a plane for patient plan verification and quality control in radiation therapy. Utilizing ion chambers avoids radiation defects, the major drawback of solid-state detectors. The vented plane-parallel ion chambers are 4.4 mm x 4.4 mm x 3 mm in size, and the center-to-center spacing is 7.1 mm. In total there are located 1405 ion chambers in a chessboard matrix, providing a maximum field size of 27 cm x 27 cm. The square chamber design offers unique 50 % field coverage. The OCTAVIUS Detector 1500 XDR can be used for the dose verification of patient plans and for machine QA. The package includes an interface for fast data acquisition. The display cycle can be set between 100 ms and 800 ms.

Ordering Information

L981464 OCTAVIUS Detector 1500 XDR
incl. electronics and BeamAdjust software

Options

S070009 VeriSoft software
S070011 MultiCheck software
E41330B/S/G Service contract Bronze, Silver or Gold

OCTAVIUS

Detector 1600 XDR

Patient plan verification and quality assurance for proton and heavy ion beams

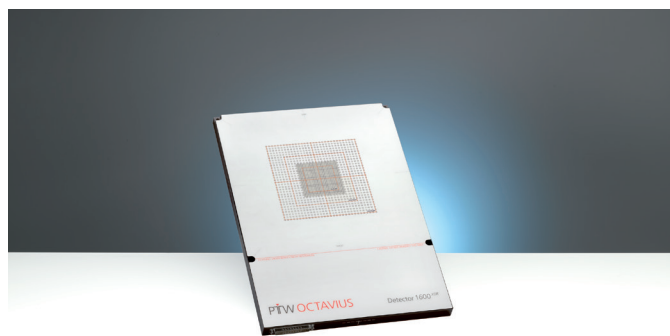

- ▶ Suitable for patient plan verification and machine QA of proton and heavy ion beams
- ▶ Outstanding detector and matrix design: 1521 vented cubic ion chambers, arranged on a 15 x 15 cm² matrix
- ▶ Pioneering ionization chamber array, flat and lightweight (6 kg)
- ▶ No ageing effects by utilizing Gold Standard ionization chamber technology
- ▶ Absolute dose calibration in ⁶⁰Co beam
- ▶ Supported by the measurement and evaluation software programs VeriSoft and BeamAdjust

The OCTAVIUS Detector 1600 XDR is a high resolution ion chamber matrix for patient plan verification and quality control radiation therapy with protons or heavy ions. Utilizing ion chambers avoids radiation defects, the major drawback of solid-state detectors. The vented plane-parallel ion chambers are 2.5 mm x 2.5 mm x 2 mm in size and the center-to-center spacing is 2.5 mm in the central area of 6.5 x 6.5 cm² and 5 mm in the area surrounding it. In total there are 1521 ion chambers, providing a maximum field size of 15 x 15 cm². The square chamber design offers unique 100 % field coverage in the central region. Read out cycles of 100 ms provide the basis for real-time analysis of beam profiles.

Ordering Information

L981585 OCTAVIUS Detector 1600 XDR
incl. electronics and BeamAdjust software

Options

S070009 VeriSoft software
E41330B/S/G Service contract Bronze, Silver or Gold

OCTAVIUS

Accessories

Optional accessories for OCTAVIUS systems (not for OCTAVIUS 4D)



OCTAVIUS mobile QA Trolley (T40053)

Robust, functionally designed trolley to conveniently store and move OCTAVIUS phantom and detector

Film Measurement (T40054.1.015)

Polystyrene holding device for OCTAVIUS octagonal phantom to insert a GafChromic® EBT / EBT 2 film (max. size 20.32 cm x 25.4 cm, 8" x 10") for film measurements

Chamber Measurement (T40042.1.010)

Insert plates for OCTAVIUS phantom with cavities to allow point measurements with up to nine 0.125 cm³ semiflex ionization chambers. Unneeded cavities can be closed with blind plugs

BQ-CHECK (T42030)

Energy verification phantom

Universal Gantry Mount

Vendor-specific gantry holding device designed to keep PTW ionization chamber arrays secure at isocenter at any gantry position



DVH	EVALUATION QUANTITY	LIMIT	REFERENCE	COMPARISON	DIFFERENCE
Brainstem					
Head & Neck	Dose coverage 60 cm ³	< 20 Gy	21.00 Gy	22.00 Gy	-50 %
	Volume coverage 30 Gy	< 10 cm ³	60 %	70 %	1 %
	Maximum dose	< 20 Gy	40.00 Gy	35.00 Gy	-0.5 %
	Minimum dose	< 20 Gy	10 Gy	10 Gy	0 %

One-stop solution for integrated patient QA

- ▶ Fully automated workflows
- ▶ Fast web-based access to QA results
- ▶ Independent Monte Carlo dose calculations with RT MonteCarlo 3D
- ▶ TRUE 3D EPID dosimetry with with RT EPID 3D¹
- ▶ Phantom-based 3D dose measurements with RT OCTAVIUS¹
- ▶ Fully integrated with Track-it

As an all-in-one multi-tasking platform, VERIQA manages all patient QA tasks efficiently in one place, from visualization and evaluation to verification and reporting. With its modular, scalable design, VERIQA gives the flexibility to combine, expand or upgrade modules as and when needed. Built on future-proof client-server architecture, it is simply accessed through its web client to browse and organize measurements, calculations and “To Do” lists or to retrieve QA results. VERIQA automates repetitive tasks and manual steps in patient QA. It streamlines all operations from data collection and analysis to approval and documentation, generates reports upon task completion, sends email alerts and notifications where actions are required, and exports QA results to Track-it for efficient case-related monitoring fully automatically. Combined with OCTAVIUS 4D measurement equipment, VERIQA automates manual setup tasks, data acquisition and analysis.

VERIQA calculates dose using a robust proprietary Monte Carlo algorithm that is truly independent of the LINAC and treatment planning system, thus providing most accurate results – even in complex situations (e.g., small fields, inhomogeneous regions). It features advanced comparison tools, including structure-based gamma volume analysis (GVH).

The optional available module VERIQA RT EPID 3D¹ provides a fully automated solution for both pre-treatment and in vivo EPID dosimetry enabling true 3D patient dose reconstruction from acquired images. VERIQA RT EPID 3D builds on the well-established back-projection algorithm developed by The Netherlands Cancer Institute – Antoni van Leeuwenhoek Hospital (NKI-AVL) for dose reconstruction refined by a unique Monte Carlo-based inhomogeneity correction (patent pending), offering significant clinical advantages.

Unlike most EPID dosimetry solutions using the so called forward approach, VERIQA RT EPID 3D enables a true 3D dose verification from the acquired EPID images by accurately reconstructing the dose in the patient anatomy. This enables direct comparison with the planned patient dose and the use of clinically relevant comparison metrics such as patient dose-volume histograms (DVHs) for all treatment sites including those with significant tissue heterogeneities.

VERIQA RT EPID 3D adapts seamlessly into the modular structure of VERIQA and expands the Patient QA platform to the verification of each treatment delivery. The trend of the EPID-reconstructed patient dose over the course of treatment is comprehensively presented per treatment plan. This ensures clear overview of the entire treatment and allows easy access to further evaluation results of individual fractions.

TASK OVERVIEW

ACQUISITION	EVALUATION	RESULT	GAMMA DISTRIBUTION	DVH EVALUATION	GAMMA EVALUATION	BEAMS USED	APPROVAL	COMMENTS
Pre-treatment								
9 Apr 2021	EPID 1	✓	✓	✓	✓	5 of 5		
Treatment								
11 Apr 2021	EPID 2	✓	✓	✓	✓	5 of 5	1	
Comparison Dose		Evaluation Creation		Last Comment		Approval History		
PTW VERIQA 3.0 RT EPID		+ 2021-04-11T09:01		Dr. Ruth Meier + 2021-04-11T16:51		Patient is losing weight. Closely monitor the trend of in vivo dose.		
12 Apr 2021	EPID 3	✓	✓	✓	✓	5 of 5		
13 Apr 2021	EPID 4	⚠	✓	✓	⚠	5 of 5		2021-04-13T17:31 Dr. Alan Vilho
14 Apr 2021	EPID 5	✗	✓	⚠	✗	5 of 5		

Ordering Information

S070031 VERIQA software

Options

- S070031.010 Option RT Evaluate
- S070031.020 Option RT MonteCarlo 3D
- L991398 RT MonteCarlo Server
- S070031.030 Option RT OCTAVIUS

¹ The modules RT EPID 3D and RT OCTAVIUS will be available in the near future.

VeriSoft® Verification Software

IMRT patient plan verification software

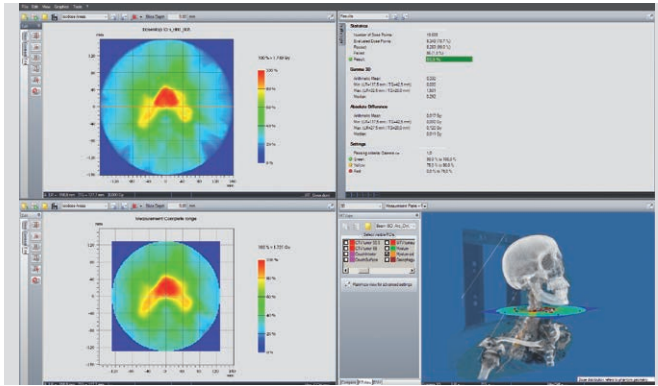

- ▶ DVH analysis in patient anatomy based on measured data independent from TPS
- ▶ 3D volume analysis
- ▶ 2D/3D Gamma index analysis
- ▶ Profile and dose distribution overlays
- ▶ Dose-difference distributions
- ▶ Results summary with “traffic light” indicator
- ▶ Gamma histograms
- ▶ Patient CT overlay

VeriSoft helps the medical physics expert to verify the IMRT treatment plan by comparing data measured in an IMRT verification phantom with data computed for the same phantom by a radiotherapy treatment planning system. Matrices of measured and calculated points of an IMRT beam are read and displayed by VeriSoft. Isodoses, profiles and numerical values can be compared. VeriSoft features several display modes.

The unique 3D volume analysis compares the dose measured inside the entire phantom volume and automatically calculates all slices of the dose volume. Failed points, measured isodoses, contours of the CTV, PTV and organs at risk can be overlaid onto the patient’s CT image to support you in your evaluation of the accuracy of dose delivery.

The optional software module DVH 4D calculates dose-volume histograms (DVHs) for each structure in less than a few minutes and compares them with the DVHs calculated by the treatment planning system (TPS). As a truly independent plan evaluation tool, DVH 4D requires no dose data from the TPS, but performs its calculations based entirely on patient CT data and OCTAVIUS 4D measurements, using a unique algorithm.

Ordering Information

S070009 VeriSoft software
 S070009.001 Option DVH 4D for VeriSoft
 E41340B/S/G Service contract Bronze, Silver or Gold

Track-it

Comprehensive software for QA data tracking



- ▶ Track and manage all of your QA data efficiently on one single platform and share it within your organization
- ▶ Export analyzed QA data from your PTW QA software to Track-it with the click of a single button
- ▶ Easily access your data from any network device simply by using a standard web browser
- ▶ Add custom data manually or import external QA data via open XML interface
- ▶ Personalize your data view by adding and/or removing parameters or data types to see on the screen
- ▶ Immediately spot deviations of selected data types, e.g., CAX or symmetry
- ▶ Show trends of selected data types to recognize outliers and deviations from previously defined limits more easily
- ▶ Track the current status of your QA tasks (completed or open, pass or fail) from anywhere in your network
- ▶ Use predefined or custom protocol templates, e.g., for AAPM TG-142 or DIN, to quickly collect the QA data you need
- ▶ Document results and print them for sign-off using custom reports
- ▶ Edit and/or create your own protocol templates to perfectly meet your facility’s requirements

Track-it allows managing and following up all kind of QA data. Measurement data from different devices can be displayed as a function of time. For maximum flexibility additional numerical data may be entered. Individual limits allow easy tracking of your QA data. Reports allow to keep track of all protocol tasks such as all TG-142 tasks. Track-it is network based. Data can be accessed from any computer or mobile device inside the network.

Ordering Information

S070027 Track-it software
 E41500B/S/G Service contract Bronze, Silver or Gold

QUICKCHECK weblin[®] Constancy Test Device

Compact and easy to use portable check device for daily constancy tests



- ▶ Suitable for all LINACs including FFF
- ▶ Uses sturdy ionization chambers
- ▶ Connects via USB, RS232 or TCP/IP to a computer or network
- ▶ Remote device control software
- ▶ Includes automatic beam quality check
- ▶ Features cordless operation with rechargeable batteries

The QUICKCHECK weblin is a highly reliable and very easy to use QC measurement device for LINAC constancy tests. 13 vented ionization chambers are integrated in a housing that contains the complete electronics. Air density corrections of the open ionization chambers are performed automatically. QUICKCHECK weblin features all the measuring tasks for daily constancy tests of the relevant LINAC parameters as symmetry, flatness, central beam dose, energy, irradiation time or wedge filtering. Settings and readings can be done directly at the device. Autostart, autostop, autopower-off and autocalendar functions allow hassle-free measurements. A remote device control software allows instant result viewing and device configuration. While not used for measurements, the device can be stored in an optional docking station. The comprehensive software package enables the user to set up worklists and to read out and analyze measured data which can be exported to Track-it.

Ordering Information

L981975	QUICKCHECK weblin including software and power cables
L981976	QUICKCHECK weblin including docking station, software and power cables
L981406	QUICKCHECK holding device
T42031.1.310	QUICKCHECK FFF Compensator X06
T42031.1.320	QUICKCHECK FFF Compensator X10
S070027	Track-it software
E41400B/S/G	Service contract Bronze, Silver or Gold

STARCHECK[®] 2D Chamber Array

Chamber matrix system to measure high-resolution star profiles of high-energy therapy beams in real-time

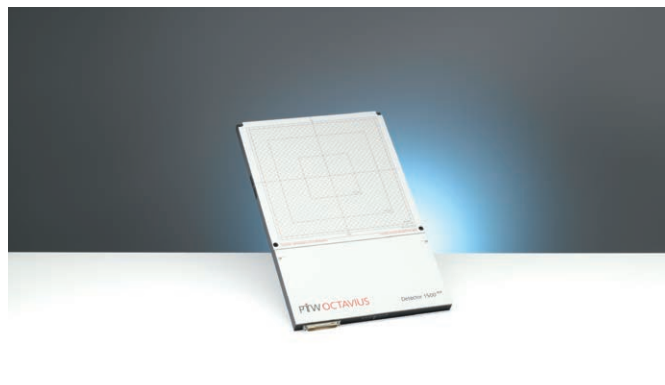

- ▶ Measures high resolution profiles along the principal axes and along the diagonals with 3 mm spatial resolution
- ▶ Checks the start-up behaviour
- ▶ Checks positions of MLC leaves
- ▶ Checks congruence between light field and radiation field and beam quality with dedicated phantoms

STARCHECK is a precise and reliable tool for fast measurements in radiation therapy beams. Typical applications are quality control and LINAC beam adjustment measurements with the detector panel embedded in a solid state phantom. The ionization chambers feature an excellent relative response stability, avoiding the need of frequent recalibration. A full set of four profiles is measured every 200 ms, making the device useful for real-time measurements. The excellent spatial resolution of only 3 mm ensures precise measurements even in penumbra regions. The scanning lengths covered by the detectors are 25.2 cm along the principal axes and 34.5 cm along the diagonals.

The optional FIELDCHECK phantom allows to measure light field and radiation field. The optional BQ-CHECK phantom is used for constancy check of the beam quality. Both phantoms are supported by the MultiCheck software. The delivery includes the detector panel, an interface box which connects to a PC via RS232 or network, real time analysis software BeamAdjust, and a quality control software MultiCheck.

Ordering Information

L981389	STARCHECK system with 527 ionization chambers, incl. interface software
---------	---

Option

E41330B/S/G	Service contract Bronze, Silver or Gold
-------------	---

STARCHECK maxi Full Size Chamber Array

Chamber matrix system to measure high resolution star profiles for fields up to 40 cm x 40 cm



- ▶ Measures fields up to a size of 40 cm x 40 cm
- ▶ Measures high-resolution (3 mm) profiles along the principal axes and along the diagonals
- ▶ Checks the start-up behaviour
- ▶ Checks congruence between light field and radiation field and beam quality with dedicated phantoms

STARCHECK maxi is a precise and reliable tool for fast measurements in radiation therapy beams. Typical applications are quality control and LINAC beam adjustment measurements with the detector panel embedded in a solid state phantom. The ionization chambers feature an excellent relative response stability, avoiding the need of frequent recalibration. A full set of 4 profiles is measured every 200 ms (or one profile every 100 ms), making the device useful for realtime measurements. The excellent spatial resolution of only 3 mm ensures precise measurements even in penumbra regions. The scanning lengths covered by the detectors are 40 cm along the principal axes and 56.5 cm along the diagonals. BeamAdjust software displays up to four profiles in realtime. The profiles can be analyzed according to selectable dosimetry protocols and the protocols of the accelerator manufacturers. The software displays the start-up behaviour with a time resolution of 100 ms. With an additional accessory plate BQ-CHECK phantom and FIELDCHECK phantom can be used with STARCHECK maxi. The STARCHECK maxi can be manually rotated using the optional rotation unit.

Ordering Information

L981377	STARCHECK maxi measuring system
T40059	Rotation unit for STARCHECK maxi
T10033.1.050	Build up plates for STARCHECK maxi
T10033.1.550	Carrying case for build up plates
T10033.1.150	STARCHECK maxi accessory plate for BQ-CHECK and FIELDCHECK
E41330B/S/G	Service contract Bronze, Silver or Gold

STARCHECK maxi MR Full Size Chamber Array

Chamber matrix system to measure high resolution star profiles for MR fields up to 40 cm x 40 cm

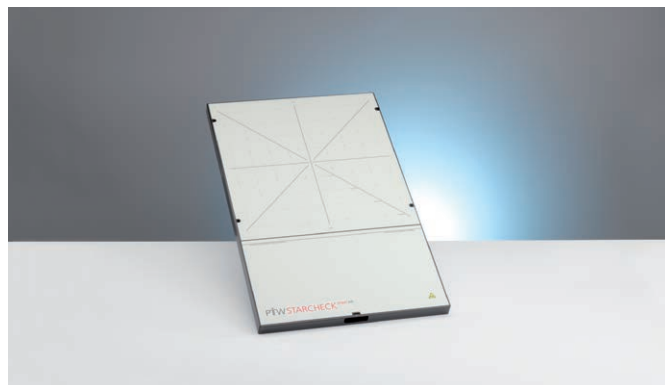

- ▶ Safe for use in high magnetic fields (≤ 1.5 T)
- ▶ Measures fields up to a size of 40 cm x 40 cm
- ▶ Measures high-resolution (3 mm) profiles along the principal axes and along the diagonals
- ▶ Checks the start-up behaviour

The STARCHECK maxi MR is a precise and reliable tool for fast measurements in radiation therapy beams. Typical applications are quality control and LINAC beam adjustment measurements with the detector panel embedded in a solid state phantom. The ionization chambers feature an excellent relative response stability, avoiding the need of frequent recalibration. A full set of 4 profiles is measured every 400 ms (or one profile every 100 ms), making the device useful for real-time measurements. The excellent spatial resolution of only 3 mm ensures precise measurements even in penumbra regions. The scanning lengths covered by the detectors are 40 cm along the principal axes and 56.5 cm along the diagonals. BeamAdjust software displays up to four profiles in real-time. The profiles can be analyzed according to selectable dosimetry protocols and the protocols of the accelerator manufacturers. The software displays the start-up behaviour with a time resolution of 100 ms. The delivery includes the detector panel, an interface box which connects to a PC via TCP/IP and data acquisition software.

Ordering Information

L981488	STARCHECK maxi MR incl. electronics and data acquisition software BeamAdjust
T10033.3.052	Build-up plate (25 mm)
E41330B/S/G	Service contract Bronze, Silver or Gold

BQ-CHECK® Test Object

Test object for constancy checks of photon and electron beam qualities using STARCHECK or OCTAVIUS Detector



- ▶ Checks the beam quality of photon and electron beams in combination with STARCHECK or OCTAVIUS Detector
- ▶ No interference with profiles on the main axes
- ▶ Comprehensive data analysis by MultiCheck software

BQ-CHECK is a phantom with 300 mm x 300 mm x 47 mm in size. It can be placed on the PTW 2D ion chamber arrays OCTAVIUS Detector 729/1500 and STARCHECK to check the constancy of the beam quality of high energy photon and electron beams.

Wedges of different materials are placed over the diagonals of the arrays. The MultiCheck software checks the constancy of the beam quality and displays a figure for each beam quality. Limits of acceptance can be adjusted. The beam quality can be tracked with a statistic function. Because the main axes are not affected by the use of BQ-CHECK the beam quality can be checked without additional workload. The beam quality analysis is part of the MultiCheck software. For the use of BQ-CHECK, MultiCheck software is needed.

Ordering Information

T42030 BQ-CHECK test object

FIELDCHECK

Checks congruence of light field and radiation field of linear accelerators

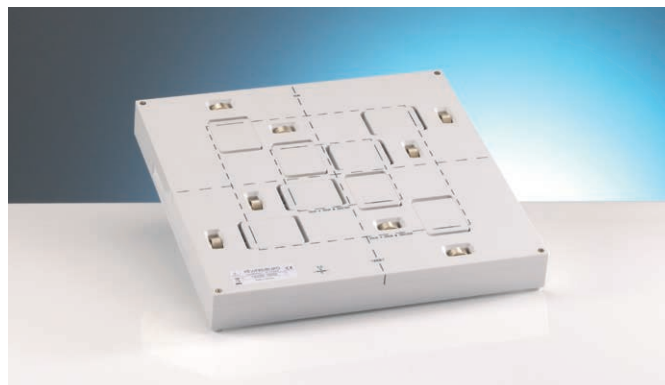

- ▶ Checks congruence of light field and radiation field in combination with STARCHECK and STARCHECK maxi 2D ionization chamber array
- ▶ Field size 10 cm x 10 cm and 20 cm x 20 cm
- ▶ Single shot measurement
- ▶ Highest precision, no film required
- ▶ Measurement analysis and documentation by MultiCheck software

Combined with the STARCHECK 2D ionization chamber array, the FIELDCHECK device is used to check the congruence of light field and radiation field. Performance and analysis of the measurements are done by means of the MultiCheck software (version 3.3 or higher).

To detect the exact position of the light field, four movable sliders are adjusted to the margins of the light field. The sliders move markers on the measuring diagonals of the STARCHECK detector.

With "beam on" the markers are displayed on the diagonals while the limits of the field size are measured on the main axes of the STARCHECK detector.

With an additional accessory plate the FIELDCHECK phantom can be used together with STARCHECK maxi.

The evaluation software MultiCheck shows size and position of both, light field and radiation field and displays the values and trends. Adjustable limits help to keep track of all parameters.

Ordering Information

T40052 FIELDCHECK phantom

MultiCheck LINAC QC Software

Software program to check the consistent performance of linear accelerators by using PTW 2D ion chamber arrays

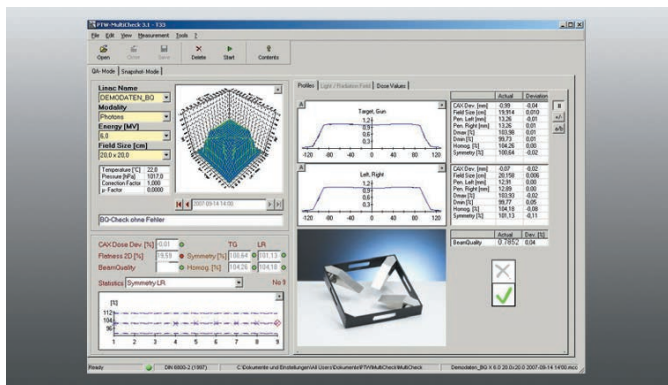

- ▶ Suitable for fast and easy daily constancy tests of photon and electron beams from LINACs using PTW 2D arrays
- ▶ Checks flatness, symmetry, dose deviation in the central axes, wedge angle of dynamic, virtual and fixed wedges as well as the congruency of light and radiation fields
- ▶ Checks beam quality with BQ-CHECK phantom
Compares all parameters to a reference data record and displays deviations
- ▶ Enables tracking parameters via a statistic function
- ▶ Creates a comprehensive data analysis according to selectable dosimetry protocols and the protocols of the accelerator manufacturers
- ▶ Provides snapshot mode for fast checking of the beam
- ▶ Analysis results can be exported to Track-it

MultiCheck is a Windows based software for fast and easy-to-handle routine constancy tests of high-energy photon and electron beams from linear accelerators. Reference files for different accelerators and different beam parameters can be defined. MultiCheck is based on two-dimensional dose measurements by the 2D ion chamber arrays. By evaluating the dose matrices, the relevant LINAC quality parameters are compared to original reference values, which are stored together with tolerance thresholds. Measuring results, parameter variations and tolerance excesses are presented in either numeric or graphic format. The progress of test results combined with statistical evaluation is shown. Profiles can be analyzed after different protocols.

The software offers air density correction of the ion chamber measuring values. The data can be exported to Excel sheets for further evaluation.

Ordering Information

S070011 MultiCheck software

EPID QC PHANTOM

Test object for quality control of Electronic Portal Imaging Devices used in high-energy photon beams



- ▶ Suitable for conventional EPIDs and flat Panel Imagers
- ▶ Checks linearity, isotropy, noise, low and high contrast resolution with test elements in focal spot geometry
- ▶ High contrast resolution in horizontal, vertical and diagonal direction
- ▶ Measurement of all parameters with a single beam in one image

Electronic Portal Imaging Devices (EPID) are used in radiation therapy to verify the patient's position in the radiation beam during treatment. EPIDs are intended to detect physiological structures of the patient and to refer to them to the photon beam's coordinate system. Regular quality checks of the EPIDs are therefore crucial to ensure constant image quality and thus a high safety level for the patient.

The EPID QC PHANTOM¹ is easy to use. Baseline images and subsequent test images are taken by irradiating the phantom with a suitable dose, depending on the type of EPID. The phantom includes test elements for all relevant parameters for a complete quality control procedure measured in a single beam. It checks linearity, isotropy, noise, low and high contrast resolution in a focal spot geometry. The phantom includes a wide range of high-contrast test patterns to perform tests even of the most advanced EPIDs available. Due to horizontal and vertical resolution in one beam, the focal spot size can be controlled with flat panel imagers. An optimized "Las Vegas" like phantom is included for low contrast analysis which enables service personnel to adjust EPID brightness and contrast using well-established procedures.

¹ The OCTAVIUS Phantom was designed by Ann van Esch and Dominique P. Huyskens from 7Sigma, Belgium.

Ordering Information

T42025 EPID QC PHANTOM

epidSoft Software

QC software to evaluate
EPID images acquired by EPID QC
PHANTOM

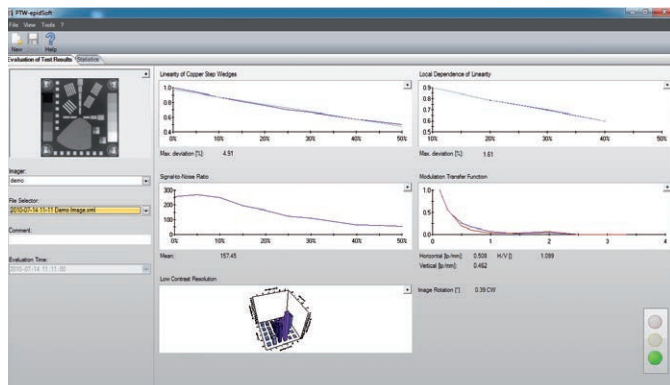

- ▶ Automatic evaluation of all parameters
- ▶ A traffic light indicates a fast "Go"
- ▶ User defined set of limits for each imager
- ▶ Statistic functions for all relevant parameters
- ▶ Supports file formats of all established EPIDs

The epidSoft software package reads images which are acquired by the EPID QC PHANTOM. An automatic position calibration and evaluation makes it very easy to use. A traffic light indicates the result of the evaluation according to the limits which can be defined by the user for each imager separately. All parameters are on a single screen and can be enlarged for detailed analysis. A statistic function allows to follow up the QC history over the whole lifetime of the imager. A long term degradation of the imager can be easily detected.

All evaluations will be stored together with the images. Printout of all parameter values and ASCII export function are available as well as an acceptance test sheet.

Ordering Information

S070010 epidSoft software
E41520B/S/G Service contract Bronze, Silver or Gold

IGRT QC Set

Test objects for image quality control of
MV and kV imagers at IGRT radiation
treatment devices



- ▶ Optimized phantoms for MV and kV beam imagers
- ▶ Measurement of all parameters with a single beam in one image

In Image Guided Radio Therapy (IGRT), most radiation treatment devices are using a kV beam to detect and correct the patient's position in the MV beam. For both beam types typically a flat panel imager is used for the image read out. To ensure a high imager quality the IGRT set contains optimized test phantoms for kV and MV imagers for consistency checks.

The EPID QC PHANTOM checks linearity, isotropy, noise, low and high contrast resolution. All test elements are focused to 100 cm focus distance, for use in 4-25 MV photon beams. A dedicated software epidSoft allows an automatic evaluation of image files acquired with the EPID QC PHANTOM. A statistic function allows following up the QC history over the whole lifetime of the imager. The NORMI RAD/FLU test object is designed for constancy tests of X-ray installations for fluoroscopy in diagnostic radiology. The test object includes a structure plate with a copper step wedge for testing the dynamic range, a resolution test pattern, low contrast and detail test elements. The NORMI RAD/FLU structure plate allows to check all parameters in one shot. For patient simulation, a 1 mm copper plate and a 30 mm PMMA is included in the set.

Ordering Information

L981097 IGRT QC set
L981425 IGRT QC set with dose measurement

ISOCHECK

Isocenter Test Device

Film phantom for checks of the LINAC isocenter geometry

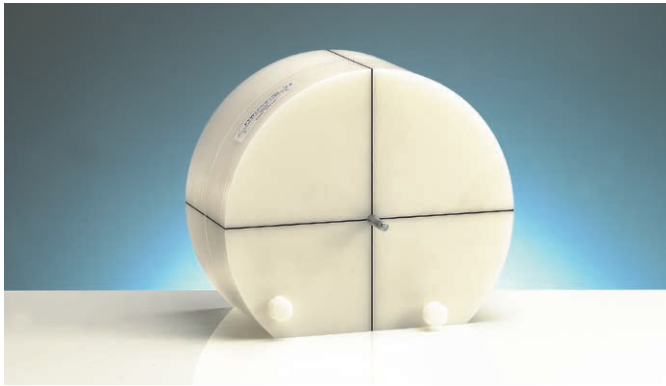

- ▶ Checks the size and position of the isocenter sphere
- ▶ Checks the conformity of the mechanical and the radiation isocenter
- ▶ Line marks and crosshairs for LASER adjustment on the table-top

The ISOCHECK test object consists of two cylindrical POM plates, each of 20 cm in diameter and 5 cm in thickness with a segment cut away to form a base. Both plates have circumferential line marks and front side crosshairs to perform easy adjustment by means of the LASER beams. The LASERS should be adjusted to the mechanical rotation axis of the accelerator gantry. An X-ray film, packed in an opaque envelope, is put between the plates and fixed by means of plastic screws. The mechanical isocenter is marked by a needle on the test film through the hole in the center of the test object. Then the test object and the film are irradiated by pencil beams under various angles of incidence. The developed film shows the pencil beams, indicating the location and size of the radiation isocenter, as well as the position of the mechanical isocenter, identified by the needle mark. The optional IsoCheck software package allows automatic starshot analysis. It checks size and position of the isocenter sphere and its distance to the laser cross. The result can be exported in an ASCII xml file and printed. IsoCheck software supports direct control of various scanner types as well as scanners with TWAIN interface. All common file formats including DICOM can be read.

Ordering Information

T42004 ISOCHECK test object and needle

Options

S070019 IsoCheck software
E41520B/S/G Service contract Bronze, Silver or Gold

IsoCheck epid

Isocenter QA Software

Software for determining the radiological rotational isocenters of a LINAC by analysing EPID images

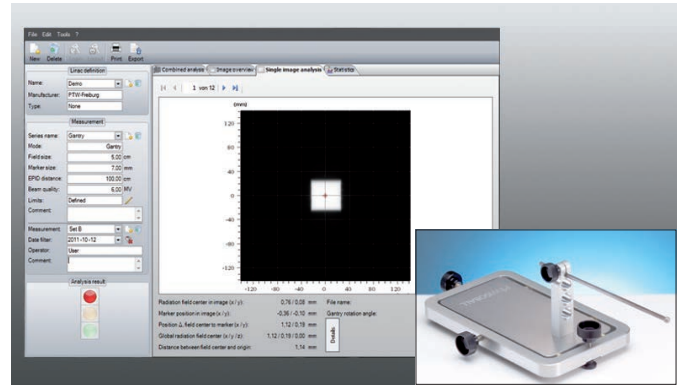

- ▶ Determines the radiological rotational isocenters of a LINAC by analysing EPID images
- ▶ Shows several levels of information:
Combined and per image analysis
Trends over time

The software IsoCheck epid helps the medical physics expert to ensure the correct positioning of the LINAC radiological rotational isocenters. This is done by comparing the position of a high density ball ISOBALL T42037 aligned to the treatment room lasers to the center of a radiation field irradiating this ball. The results can be displayed visually or numerically. Trends over time can be displayed in a separate QA statistics tab.

Ordering Information

S070023 IsoCheck epid software

Option

T42037 ISOBALL isocenter marker

SC Holding Device Universal Gantry Mount

Universal sturdy holding device for gantry mounts of any measuring equipment to different LINAC types

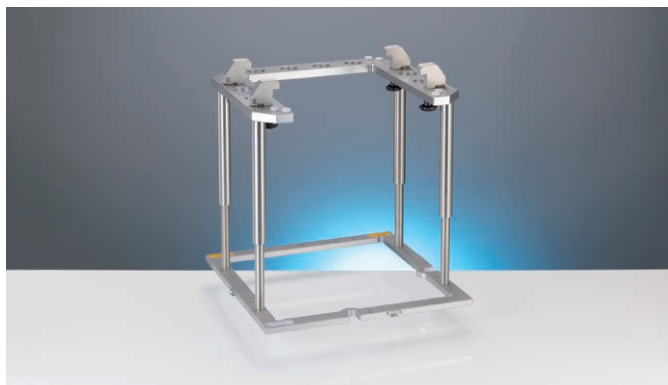

- ▶ Mounts to different LINAC types without interfering with accessory tray guide rails and with electron cones
- ▶ Accommodates any detector and phantom assembly for measurements in the isocenter
- ▶ Universal tool for any therapy dosimetry task at arbitrary gantry angles

The SC holding device is a very stable mechanism, which is available for different types of LINAC gantries. It does not interfere with the guide rails of the accessory tray and with an attached electron cone. These features make the SC holding device a real universal tool for therapy dosimetry using any dosimetry assembly at any gantry angle. A solid mounting frame at the holding device makes it possible to position any phantom-detector combination in the isocenter. As an example, single radiation detectors can be placed in an acrylic or RW3 phantom, or a 2D chamber matrix can be attached for online measurements in a plane.

Ordering Information

T41021.1.070	SC holding device for Elekta
T41021.1.030	SC holding device for Varian
T41021.1.110	Chamber plate holder
T41021.1.150	Chamber/cable clamping device
T41021.1.170	Holder for OCTAVIUS Detectors and STARCHECK
T41021.1.210	Holder for OCTAVIUS Detectors and STARCHECK incl. 10 cm PMMA build-up

SOURCECHECK 4 π Well-type chamber

Well-type ionization chamber for source strength measurements in brachytherapy



- ▶ Measures low energy seeds and high energy afterloading sources
- ▶ Measures all sources in a full 4 π geometry
- ▶ Adapters for all commercial afterloading devices and seeds
- ▶ User friendly accessories for fast and safe handling
- ▶ Compatible to high class PTW dosimeters
- ▶ Calibration for Ir-192, Co-60 and for I-125 available

The SOURCECHECK 4 π well-type ionization chamber is suitable for source strength measurements of all kind of brachytherapy sources. International standards require the measurement of radioactive brachytherapy sources. For HDR afterloading sources an acceptance test after the replacement of the source and additional constancy checks are required. For permanent implanted seeds the typical quality assurance is measuring a defined amount seeds out of a delivered batch.

Various adapters for all kind of afterloading applicators and for different seeds and seed strands are available. The radioactive check source T48010 can be used for constancy checks. The chamber can be calibrated for Ir-192, Co-60 and for I-125.

Ordering Information

TN33005	SOURCECHECK 4 π , connecting system BNT
TW33005	SOURCECHECK 4 π , connecting system TNC
TM33005	SOURCECHECK 4 π , connecting system M

Options

T48010	Check device 90-Sr, point source
T33005.1.020	SOURCECHECK radioactive check source adapter
E21272	SOURCECHECK calibration Ir-192
E21271	SOURCECHECK calibration I-125

Adapters for afterloading applicators, seeds and seed strands upon request

Diagnostic Imaging



60 Years DIAMENTOR®

The Story of the Dose Area Product Meter

In **1957** *Herbert Pychlau* had the idea of a new diagnostic measuring device determining the patient load during medical X-ray examinations. This measuring device was meant to show young radiologists working in a teaching hospital the patient dose consequences of radiological procedures also considering minimizing techniques like collimation or filtration adjustment. *Herbert Pychlau* invented a new measuring quantity based on the inverse square law, which he named the "Dose Area Product (DAP)". The DAP is the product of the multiplication of the entrance dose and the area of the irradiated field. Doubling the distance increases the radiation area by factor four, while the dose decreases simultaneously by factor four. Both effects cancel out each other and therefore the new unit [Rcm²] was ideal for educational measurements as it is independent of the focus patient distance.

Two years later in **1959** PTW released the first DAP meter worldwide called DIAMENTOR. The measuring principle: An ionization chamber installed to the X-ray collimator determines the patient radiation load during X-ray examinations while the DIAMENTOR electronics measure and display the DAP value.

The following years *Herbert Pychlau* and his son Peter struggled with a host of problems introducing the DIAMENTOR into routine clinical work. Starting with technical issues (non-transparency of the first original chamber) and continuing through user handling difficulties (chamber maintenance and problems in understanding the meaning of the new measuring quantity) up to difficulties with public authority acceptance.

In **1964** the study "*Messung der Patientendosis in der Röntgendiagnostik*" was published by *E. Bunde and Peter Pychlau*, showing the correlation between the DAP and the patient load. This work found such a great national and international recognition that a working group was founded with the aim to define a national German standard establishing legal rules how to use DAP meters in X-ray diagnostic departments.

For reading the whole
Story of the Dose Area Product Meter
please scan the QR code:



Today the DIAMENTOR is going stronger than ever before. It is a must in X-ray diagnostics worldwide, not only helping to reduce patient exposure, but also being an independent quality control tool, informing the operator about any deviation of the X-ray unit constancy. Since five decades the measuring principle is still the same while the PTW DIAMENTOR product portfolio of course changed: PTW provides integrated, built-in, multi channel, wireless and combined dose and DAP DIAMENTOR solutions. Over the years PTW as pioneer of the DAP meter has delivered many thousands of reliable instruments to satisfied customers worldwide.

Reference Dosimetry

▶ NOMEX Multimeter Dosimetry System	53
▶ NOMEX mAs Invasive mAs Meter	53
▶ R/F/D and MAM Detectors	54
▶ SFD Chamber for Diagnostic X-Rays	54
▶ CTDI Equipment for CT Dosimetry	55
▶ HVL Measuring Stand	55
▶ Al and Cu Filter Sets	56

Reference Dosimetry

The dose output of X-ray tubes is one of the most important parameters for image quality and patient exposure to radiation in diagnostic radiology. The dose output has to be checked very carefully during acceptance tests after installation and regularly during routine quality control. PTW manufactures a variety of high precision dosimeters for this purpose, including the NOMEX Multimeter.

Detectors are calibrated exactly for their range of use. Depending on the application, our secondary standard dosimetry laboratories perform calibrations in a wide energy range from low energy X-rays up to ^{60}Co and in a wide dose rate range. Calibration factors are given for measurements in the unfiltered beam or behind an absorber. A variety of patient equivalent absorbers for different purposes complete the range of dosimetry accessories.

The dosimetric test equipment from PTW is widely used by X-ray technicians working in companies manufacturing X-ray equipment and by public agencies monitoring technical standards, as well as by medical physicists and technicians in hospitals. The instruments are self-explanatory and consequently easy to use. Many satisfied customers worldwide could not imagine working without their reliable dosimeters from PTW.

NOMEX® Multimeter Dosimetry System

Multimeter for reference dosimetry
in diagnostic radiology



- ▶ Combined electronics and detector matrix
- ▶ Connection via USB directly to a PC
- ▶ Automatic range for dose and kV measurement

The NOMEX Multimeter is a miniaturized non-invasive measuring system for reference dosimetry and quality control in X-ray diagnostic radiology. It can be used for radiography, fluoroscopy, dental, CT and mammography application. NOMEX measures the dose, dose rate, exposure time, dose per pulse, pulses, kVp, TF and the HVL in one single shot. Additionally, the kV and dose rate waveform is stored. The smart NOMEX Multimeter can be directly connected via USB to a PC running the NOMEX software. No additional accessories like a power supply or display are required for putting the NOMEX into operation. Measurements are automatically started upon detection of radiation. The dose and kV ranges are set fully automatically almost in real-time, so that multiple exposures are avoided. The NOMEX software allows most convenient and clear data handling. Statistics functions are provided as well as data export to Excel or as XML or CSV file.

Ordering Information

L981815	NOMEX Multimeter all-in
L981533	NOMEX Multimeter all-in with mAs option
L981606	NOMEX Multimeter R/F/MAM
L981610	NOMEX Multimeter R/F/MAM with mAs option
L981611	NOMEX Multimeter R/F
L981612	NOMEX Multimeter R/F with mAs option
L981613	NOMEX Multimeter MAM
L981614	NOMEX Multimeter MAM with mAs option
L981617	NOMEX Multimeter CT
L981618	NOMEX Multimeter CT with mAs option
L981599	NOMEX Multimeter IGRT
L981600	NOMEX Multimeter IGRT with mAs option
E41700B/S/G	Service contract Bronze, Silver or Gold

NOMEX® mAs Invasive mAs meter

Invasive mAs meter for measuring
the current time product on diagnostic
X-ray generators



- ▶ Allows non-invasive measurements by means of connecting an mAs clamp optionally
- ▶ Measures current, current time product, mAs per pulse, measuring time, pulses, frequency and current waveform
- ▶ Provides auto ranging and auto start/stop
- ▶ For single or simultaneous usage in combination with the NOMEX system

The NOMEX mAs is an invasive meter for measuring the current time product (mAs) on diagnostic X-ray generators. For invasive measurements the NOMEX mAs connects to the generator of the X-ray unit via banana plugs. Optionally, non-invasive mA and mAs measurements can be performed by means of connecting a current clamp directly to the NOMEX mAs.

The NOMEX mAs can be used as a stand-alone device or simultaneously with the NOMEX Multimeter. In single operation, the NOMEX mAs connects via USB to a PC running the NOMEX Software.

The NOMEX mAs sets up fully automatically. When being used in combination with the NOMEX Multimeter, mA, mAs and mA waveform will be measured at the same time with the dose, dose rate dose per pulse, pulses, frequency, time kVp, HVL, total filtration and the waveforms for both, dose rate and kV. The measurements will be stored within the NOMEX Software and can be exported for further data analysis e.g. to Excel.

Ordering Information

L981530	NOMEX mAs
L981529	Current clamp for NOMEX mAs

R/F/D and MAM Detectors

Semiconductor detectors for diagnostic X-rays



- ▶ Fully comply with IEC 61674
- ▶ Small size and lightweight precision probes
- ▶ For acceptance testing, service and QC in X-ray diagnostics

The R/F/D and MAM detectors are sturdy semiconductor detectors designed to withstand tough handling. Air density corrections (measurement of air pressure and temperature) are unnecessary. The detectors do not need a high voltage supply. Fully compliant to IEC 61674 they are suitable for measurements during acceptance tests, service and quality control procedures.

Two detector types are available, covering either the radiography/fluoroscopy and dental range (40 ... 150) kV or the mammography range (25 ... 45) kV.

The following quantities can be measured in conjunction with e.g. the NOMEX Dosimeter:

- ▶ air kerma and dose in the conventional range
- ▶ air kerma and dose in the dental range
- ▶ air kerma and dose in mammography
- ▶ dose per pulse and number of pulses in fluoroscopy and irradiation time

Ordering Information

Connecting system TNC or L:

60004	R/F/D detector
60005	MAM detector

Options

T26077-0,3	Adapter cable 'L0,3w'
T26078-0,3	Adapter cable 'L0,3n'
T26079-0,3	Adapter cable 'L0,3m'
T20002	Cassette adapter, (18 x 24) cm
E41150B/S/G	Service contract Bronze, Silver or Gold

SFD Chamber for Diagnostic X-Rays

Shadow free ionization chamber 6 cm³ for reference dosimetry



- ▶ Plane-parallel chamber for the measurement and monitoring of radiation output in diagnostic radiology
- ▶ Shadow free design causes no interference with automatic exposure control (AEC)
- ▶ For measurements in front of and behind a phantom

The high precision SFD chamber suitable for mammography has a sensitive volume of 6 cm³. The energy response for mammography radiation qualities (25 ... 35) kV is better than $\leq \pm 2\%$ and within the conventional range is better than $\leq \pm 3\%$. The flat SFD chamber is used for dose and dose rate measurements in front and behind of a patient-equivalent phantom. Because of their shadow free construction and low attenuation the chamber gives near to no interference with the phototimer, reduce effects with the AEC and cause almost no influence like shadows on the image. Furthermore HVL measurements can be performed conveniently using a special chamber holder in combination with the HVL measuring stand.

The chamber complies fully with IEC 61674.

Ordering Information

SFD chamber, connecting system BNT, TNC, M or L:
34069 SFD MAM chamber 6 cm³

Options

T34069.1.050 Chamber holder for 34069
E41150B/S/G Service contract Bronze, Silver or Gold

CTDI Equipment for CT Dosimetry

Accessories for determination of CTDI in computed tomography

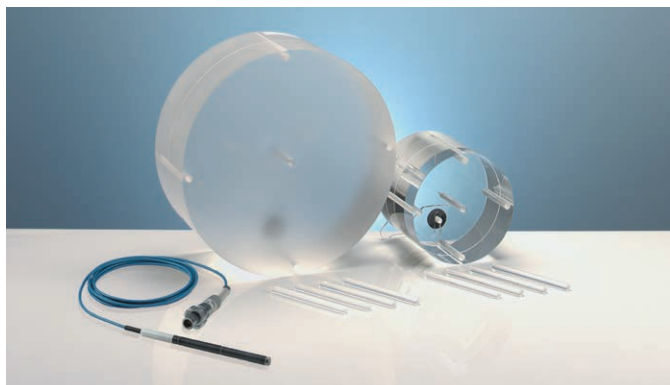

- ▶ For measurements acc. IEC 61223-3-5
- ▶ CT ion chamber, sensitive length 10 cm
- ▶ Body phantom, 32 cm Ø, head phantom, 16 cm Ø and the pediatric head phantom 10 cm Ø, all acrylic cylinders of 15 cm height
- ▶ Combined head and body phantom is available

The CT chamber 30009 is inserted for CTDI measurements into one of the five holes of the head or body phantom. Holes not used are filled by acrylic dummy plugs. Etched crosshairs on the phantoms allow exact alignment.

Ordering Information

CT chambers, connecting system BNT, TNC or M:

30009	CT ion chamber 3.14 cm ³ , 100 mm long
T40016	CT body phantom
T40017	CT head phantom
T40027	CT head and body phantom
T40073	Pediatric CT head phantom

Options

T40016.1.010	Carrying case for body phantom
T40017.1.010	Carrying case for head phantom
T40027.1.050	Carrying case for head and body phantom

HVL Measuring Stand

Measuring stand for an ideal performance of half value layer (HVL) measurements



- ▶ Accommodates an Al or a Cu filter
- ▶ Accommodates a radiation detector
- ▶ Suitable for HVL measurements at overcouch and undercouch tube installations

Measurements of the half value layer (HVL) are performed during acceptance tests to determine the beam quality of X-ray installations in diagnostic radiology as well as in diagnostic therapy. The HVL measuring stand enables the user to position a detector and a HVL filter easily. Convenient undercouch measurements as well as HVL measurements in computed tomography can be carried out by using the HVL measuring stand with its U-shaped tripod.

The set includes an universal detector holder enabling the user to fix different detectors to the stand. An optional carrying case to accommodate the HVL measuring stand and up to 13 HVL filters is available.

Ordering Information

T20008	HVL measuring stand
T20008.1.020	Carrying case for HVL measuring stand

Al and Cu Filter Sets

Al and Cu filters for precise half value layer (HVL) measurements



- ▶ Include high purity Al and Cu material
- ▶ Comply with IEC 60601-1-3

The extremely high purity of the aluminium and copper filter material enables high precision measurements of the X-ray beam quality in diagnostic radiology and in diagnostic therapy. The useful filter size is (80 x 80) mm and the outer dimensions are (100 x 100) mm.

Ordering Information

L981957	99.99 % Al filter set RAD/FLU (7 Al-layers; 1 x 0.1 mm; 2 x 0.2 mm; 1 x 0.5 mm; 1 x 1 mm and 2 x 2 mm thickness)
L981956	99.99 % Al filter set MAM (4 Al-layers; 1 x 0.1 mm; 2 x 0.2 mm and 1 x 0.5 mm thickness)
T43009.1.910	99.9 % Cu filter set (13 Cu-layers; 1 x 0.01 mm; 2 x 0.02 mm; 1 x 0.05 mm; 1 x 0.1 mm; 2 x 0.2 mm; 1 x 0.5 mm; 1 x 1 mm; 2 x 2 mm; 1 x 5 mm; 1 x 10 mm thickness)

Single Al and Cu filters are available

Quality Control

▶ NOMEX Multimeter Dosimetry System	59
▶ NOMEX mAs Invasive mAs meter	59
▶ NORMI RAD/FLU X-Ray Test Object	60
▶ NORMI 13 X-Ray Test Object	60
▶ NORMI 3D DVT Test Object	61
▶ X-Check DSA Test Object	61
▶ NORMI MAM digital X-Ray Test Object	62
▶ Centric Cross Image Ruler	62
▶ Test Pattern for X-Ray Image Tests	62
▶ QRM Phantoms	63
▶ Luminance and Illuminance Meter Set	64

Quality Control

The quality of X-ray images is influenced by a number of parameters. To maintain the consistent performance of X-ray installations, quality checks have to be conducted regularly. International regulations demand quality test procedures for all types of X-ray equipment. Regular quality controls ensure proper functioning of the medical X-ray devices, reduce patient exposure, avoid unnecessary double exposures and consequently even reduce the costs of X-ray departments. The various components of the imaging chain are ideally tested independently to identify malfunctions and eliminate those detected easily.

PTW offers a variety of diagnostic test tools for different X-ray equipment. The PTW product line includes non-invasive multimeters, kV meters and test objects for quality checks of radiographic, fluoroscopic, mammographic, dental, DSA and CT installations. The QC sets include the basic test objects.

NOMEX® Multimeter Dosimetry System

Multimeter for reference dosimetry
in diagnostic radiology



- ▶ Combined electronics and detector matrix
- ▶ Connection via USB directly to a PC
- ▶ Automatic range for dose and kV measurement

The NOMEX Multimeter is a miniaturized non-invasive measuring system for reference dosimetry and quality control in X-ray diagnostic radiology. It can be used for radiography, fluoroscopy, dental, CT and mammography application. NOMEX measures the dose, dose rate, exposure time, dose per pulse, pulses, kVp, TF and the HVL in one single shot. Additionally, the kV and dose rate waveform is stored. The smart NOMEX Multimeter can be directly connected via USB to a PC running the NOMEX software. No additional accessories like a power supply or display are required for putting the NOMEX into operation. Measurements are automatically started upon detection of radiation. The dose and kV ranges are set fully automatically almost in real-time, so that multiple exposures are avoided. The NOMEX software allows most convenient and clear data handling. Statistics functions are provided as well as data export to Excel or as XML or CSV file.

Ordering Information

L981815	NOMEX Multimeter all-in
L981533	NOMEX Multimeter all-in with mAs option
L981606	NOMEX Multimeter R/F/MAM
L981610	NOMEX Multimeter R/F/MAM with mAs option
L981611	NOMEX Multimeter R/F
L981612	NOMEX Multimeter R/F with mAs option
L981613	NOMEX Multimeter MAM
L981614	NOMEX Multimeter MAM with mAs option
L981617	NOMEX Multimeter CT
L981618	NOMEX Multimeter CT with mAs option
L981599	NOMEX Multimeter IGRT
L981600	NOMEX Multimeter IGRT with mAs option
E41700B/S/G	Service contract Bronze, Silver or Gold

NOMEX® mAs Invasive mAs meter

Invasive mAs meter for measuring
the current time product on diagnostic
X-ray generators



- ▶ Allows non-invasive measurements by means of connecting an mAs clamp optionally
- ▶ Measures current, current time product, mAs per pulse, measuring time, pulses, frequency and current waveform
- ▶ Provides auto ranging and auto start/stop
- ▶ For single or simultaneous usage in combination with the NOMEX system

The NOMEX mAs is an invasive meter for measuring the current time product (mAs) on diagnostic X-ray generators. For invasive measurements the NOMEX mAs connects to the generator of the X-ray unit via banana plugs. Optionally, non-invasive mA and mAs measurements can be performed by means of connecting a current clamp directly to the NOMEX mAs.

The NOMEX mAs can be used as a stand-alone device or simultaneously with the NOMEX Multimeter. In single operation, the NOMEX mAs connects via USB to a PC running the NOMEX Software.

The NOMEX mAs sets up fully automatically. When being used in combination with the NOMEX Multimeter, mA, mAs and mA waveform will be measured at the same time with the dose, dose rate dose per pulse, pulses, frequency, time kVp, HVL, total filtration and the waveforms for both, dose rate and kV. The measurements will be stored within the NOMEX Software and can be exported for further data analysis e.g. to Excel.

Ordering Information

L981530	NOMEX mAs
L981529	Current clamp for NOMEX mAs

NORMI® RAD/FLU X-Ray Test Object

Test object for quality control of analogue and digital fluoroscopic and radiographic X-ray installations

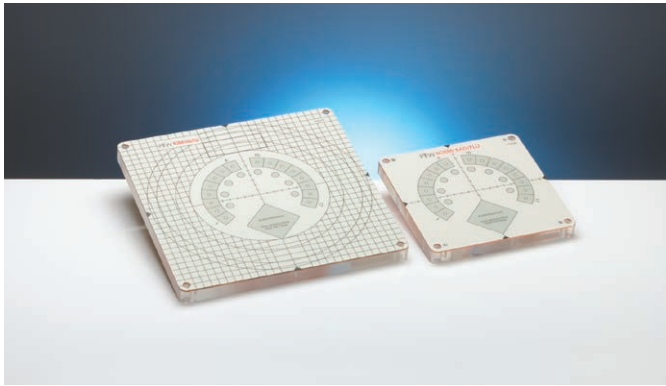

- ▶ Checks all relevant parameters of analogue and digital fluoroscopic and radiographic X-ray units
- ▶ Suitable for routine acceptance quality checks on over couch tubes, under couch tubes and C arms
- ▶ Includes an attenuation plate for patient simulation
- ▶ Complies with DIN 6868-4 and 6868-150

The NORMI RAD/FLU test object is used for acceptance and constancy tests of analogue and digital X-ray installations for fluoroscopy. The NORMI RAD/FLU structure plate includes a copper step wedge for testing the dynamic range, a resolution test pattern, low contrast and detail test elements. The structure plate allows to check all parameters in one shot. Four different NORMI RAD/FLU packages are available, either with the outer format (200 x 200) mm or (300 x 300) mm and either with a 30 mm thick PMMA plate, a 1 mm thick copper plate or a 25 mm thick aluminum absorber which must be used for acceptance tests for patient simulation. Furthermore, each package includes assembling parts which allow a convenient adjustment on over couch tubes, under couch tubes and C arms.

Ordering Information

L981302 NORMI RAD/FLU Set Al (300 x 300) mm
L981309 NORMI RAD/FLU Set Al (200 x 200) mm
L981301 NORMI RAD/FLU Set PMMA (300 x 300) mm

Options

L981473 NORMI holder for bucky wall stand

NORMI® 13 X-Ray Test Object

Test object for quality control of digital X-ray installations

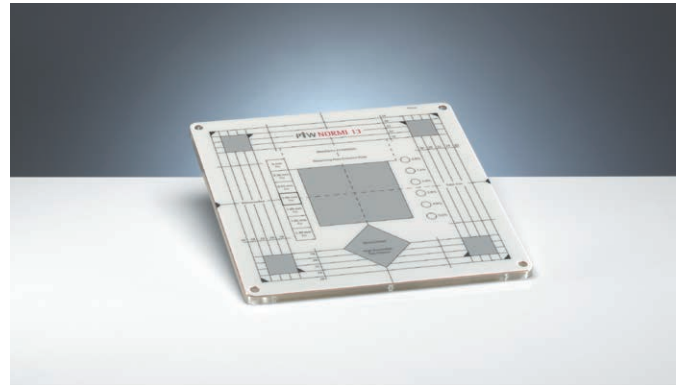

- ▶ Checks the relevant parameters of digital X-ray equipment (DR and CR systems)
- ▶ Suitable for constancy tests in digital radiography
- ▶ For use with an attenuation plate for patient simulation and a dosimeter for entrance dose measurement
- ▶ Complies with DIN 6868-13

The NORMI 13 test object is designed for constancy tests of X-ray equipment with a digital image intensifier or plate. It includes a structure plate with radiological visible line marks for the light field adjustment and the test of the light field/radiation field congruency, a gray scale test, a low-contrast test, a line group resolution test pattern, an area for entrance dose measurement and homogeneous areas for homogeneity tests and signal normalization.

The structure plate is used in combination with a 30 mm thick acrylic attenuation plate or a 25 mm Al plate to simulate patient absorption. The external dimensions of the plates are (300 x 300) mm.

Ordering Information

L981246 NORMI 13 Set Al
L981247 NORMI 13 Set PMMA

Options

L981473 NORMI holder for bucky wall stand

NORMI® 3D DVT Test Object

Test object for quality control
of digital volume tomography (3D)
X-ray installations



- ▶ Test object for testing the spatial resolution at DVT systems for ENT and at C arm systems with 3D function
- ▶ Fully complies with DIN 6868-150
- ▶ Consists out of a 10 mm thick detail plate embedded between two 25 mm thick PMMA absorbers
- ▶ PMMA detail plate incl. four cylindrical cavities with different diameters 0.5/0.6/0.7/0.8/0.9/1/1.3 mm which are arranged parallel to the z-axis

NORMI 3D is a test object for quality control and acceptance tests of digital volume tomography (DVT) X-ray installations as well as for DVT installations with integrated imaging function according to DIN 6868 part 150. The NORMI 3D consists out of three PMMA plates, while the detail objects, bore holes with seven different diameters are embedded in the middle plate. The bore holes are within a 30 mm radius in parallel with the Z-axis. Furthermore, the whole test object has a continuous bore hole with a diameter of 2.5 mm.

Ordering Information

T42038 NORMI 3D

X-Check® DSA Test Object

X-ray test object for quality control
of DSA installations



- ▶ Suitable for acceptance and constancy tests of DSA installations
- ▶ Complies with IEC 61223-3-3, DIN 6868-4 and DIN 6868-150
- ▶ Simulates the contrast agent within vessels
- ▶ Includes pneumatic remote control of the movable slider, extension 8 m

X-Check DSA is a test object for quality checks of Digital Subtraction Angiography equipment (DSA). The size of the acrylic phantom is (150 x 150 x 57) mm. X-Check DSA includes a 6 mm thick acrylic slider with manual remote-control and contains four Al strips for vessel simulation to check the dynamic range and artifacts. Sensitivity checks are conducted by means of a copper step wedge with 7 steps in 0.2 mm increments. An additional copper step of 1.4 to 0.2 mm makes it possible to evaluate logarithmic errors.

Ordering Information

T42003 X-Check DSA test object

Option

T42003.1.006 X-Check DSA frame

NORMI® MAM digital X-Ray Test Object

Test object for acceptance and constancy tests of X-ray installations for digital mammography

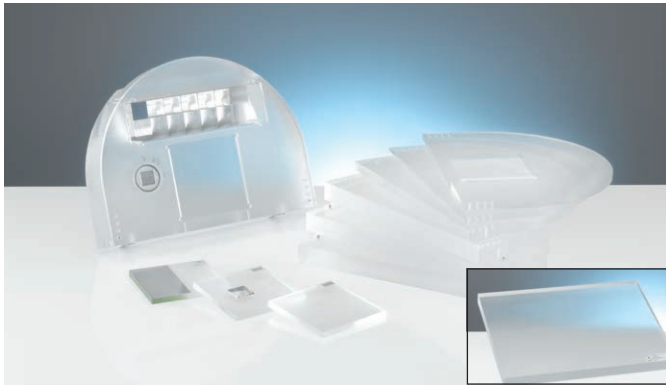

- ▶ Checks all relevant parameters of digital mammographic X-ray installations
- ▶ Fully complies with DIN 6868-162 and DIN 6868-14
- ▶ Modularly composed CE marked class I certified test object incl. different absorbers and test elements
- ▶ Retrofit sets for PTW NORMI PAS test objects available

NORMI MAM digital is used for acceptance and constancy tests of digital mammographic X-ray units. The modularly composed test object includes a basic phantom, a structure plate, PMMA absorbers and different test elements for insertion into the structure plate. The basic plate has an inclined aluminum step wedge with 14 ranges for testing the dynamic range. Two lines of five steel balls each symmetrically placed in the structure plate and in the basic attenuation phantom show the limitations on the thoracic wall side.

The PMMA absorbers can be used for tests of the automatic exposure control (AEC). Furthermore, different test elements can be placed into the cut-out provided in the structure plate. The test element SDNR is used to determine the average pixel values for the determination of the signal-difference-to-noise ratio. The high contrast can be tested with the test element HK, while the PMMA test element is used for checking the average grey value. Different sets, as well as retrofit sets for the NORMI PAS are available.

Ordering Information

L981426 NORMI MAM digital set 162
L981492 NORMI MAM digital set 14
T40046 PMMA absorber (300 x 300 x 40) mm

Centric Cross Image Ruler

Cross ruler to determine image locations on intensifier screens

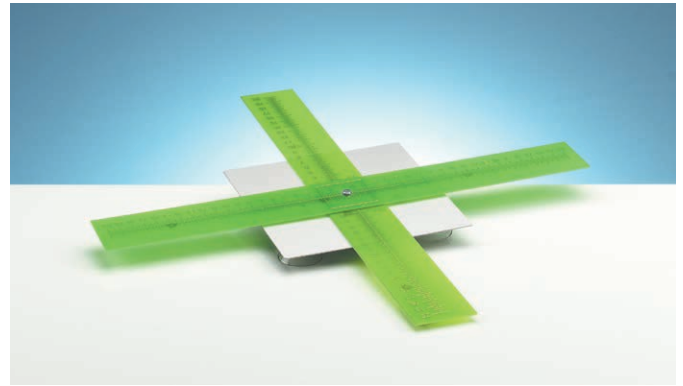

- ▶ Small mechanical test tool to check the correct centering of intensifier screens
- ▶ Enables easy adjustment at fluoroscopic installations
Presents radiopaque scales on a fluoroscopic monitor

The centric cross is mounted on a base plate of (16 x 16) cm, made of aluminum. Two 20 cm rulers, starting from the center, can be adjusted as a cross and can be centered easily. The centric cross is fixed by means of suction cups.

Ordering Information

T43010.1.001 Centric cross

Test Patterns for X-Ray Image Tests

Lead foil test patterns for X-ray resolution, focal spot size and MTF tests

- ▶ Enable easy quality checks of X-ray imaging chains
- ▶ Spatial frequencies are given in line pairs per mm (lp/mm)

Ordering Information

L659005 X-ray group test pattern
L659066 X-ray group test pattern, (0.6 – 5.0) lp/mm
L659150 X-ray group test pattern, mammography, tin
L659093 X-ray test pattern, digital mammo
L659035 Single sector test pattern, 0.4°, 20 lp/mm

QRM Phantoms

Phantoms for medical and industrial X-ray applications



- ▶ Dedicated phantom solutions for diagnostic radiology, radiotherapy, bone densitometry (DXA and qCT), Micro-CT / Micro-PET for small animal research, Cone-Beam CT and many other applications
- ▶ Tissue-equivalent materials (TEM) mimic human tissues according to ICRU Reports 44 and 46
- ▶ Unique solutions: Micro-CT Bar Pattern Phantom
- ▶ Customized solutions according to your specification

QRM (Quality Assurance in Radiology and Medicine) was founded 1994 by Professor Willi A. Kalender as a university spin-off of the Institute of Medical Physics in Erlangen, Germany, for the development, design, construction, and production of phantoms for quality assurance in X-ray imaging and associated procedures. Since April 2020 QRM is a subsidiary of PTW Freiburg GmbH.

QRM phantoms available include:

Cone-Beam Phantom

- ▶ Complete solution for the imaging performance of computed tomography (CT), and Cone-Beam CT
- ▶ Suitable to evaluate image quality parameters (CT value uniformity, CT value accuracy, image noise, contrast-to-noise ratio, spatial resolution, geometric accuracy in-plane, low-contrast capabilities)

Spectral CT Phantom

- ▶ Test different types of computed tomography (CT) scanners with dual-energy, multi-energy or photon-counting protocols and post-processing techniques in terms of accuracy and consistency
- ▶ Different solid rods: Iodine, calcium, water and soft tissue-equivalent materials such as adipose, muscle, liver and lung
- ▶ Available with different tissue-equivalent inserts

European Spine Phantom

- ▶ To evaluate bone mineral density
- ▶ For cross-calibration of CT and DXA
- ▶ For DXA (dual-energy x-ray absorptiometry) and qCT (quantitative computed tomography)
- ▶ Three vertebrae (L1/L2/L3) with different dimensions and bone mineral content

Bone Density Calibration Phantom

- ▶ HU vs. CaHA calibration with respect to bone mineral density evaluation of bones
- ▶ Several options with different lengths and HA inserts
- ▶ Easy to use as placed directly under an object

Micro-CT HA Phantom

- ▶ Worldwide standard for measuring small animal Micro-CT bone mineral density
- ▶ 5 different inserts with various CaHA densities (0, 50, 200, 800, and 1200 mg HA/cm³)
- ▶ Available diameters 4.5/10/20/25/32 mm

Micro-CT Bar Pattern Nano Phantom

- ▶ For the evaluation of in-plane and axial high spatial resolution down to 1 micron
- ▶ Center and corner sections providing several bars and point patterns between 1-10 micron
- ▶ Chip with 2 actinomorphic stars

Comprehensive Electron Density Phantom

- ▶ To create electron density calibration curve of computed tomography (CT) scanners for treatment planning systems (TPS)
- ▶ Suitable for electron, photon, and proton therapy systems
- ▶ Multi-energy CT and photon-counting applications beyond your expectations
- ▶ Available materials: 8 body and 8 head inserts
- ▶ Tissue equivalent materials: Muscle, adipose, liver, blood, brain, bone, cortical bone, lung, breast, polyethylene
- ▶ Optional titanium, stainless steel, or aluminum inserts
- ▶ Calibration certificate with densities, electron density and effective Z

For further information visit qrm.de or contact your local PTW representative.



Luminance and Illuminance Meter Set

Digital luminance and illuminance meter for quality control of viewing boxes and image display devices



- ▶ Measures the luminance of viewing boxes and image display devices
- ▶ Usage in combination with a test picture

The quality of film viewing boxes and monitors in X-ray diagnostics has to be monitored regularly. Boxes and image display devices are tested easily by using the battery operated MAVO-SPOT 2 USB, which measures the luminance in cd/m^2 .

Ordering Information

-
- L981495 Luminance and illuminance meter set incl. MAVO-SPOT 2 USB and MAVOLUX 5032 C BASE
 - L981496 MAVOLUX 5032 B precision lux meter

Patient Dosimetry

▶ DIAMENTOR RS-KD DAP/Dose Meter	67
▶ DIAMENTOR C-RS DAP Meter	67
▶ DIAMENTOR Accessories	68

Patient Dosimetry

Patient exposure has to be determined, documented and evaluated according to international regulations. The DIAMENTOR patient dosimetry systems are our solution for diagnostic radiology to fulfill these requirements. Its major features are:

- ▶ Measures and protocols the dose area product (DAP) and/or dose during X-ray examinations, especially during high dose and high risk examinations such as:
 - Angiography, including DSA
 - Cardiology
 - Interventional radiology
 - Pediatrics
 - Fluoroscopy
- ▶ Informs the practitioner of the amount of radiation applied to the patient
- ▶ Mounts firmly to the X-ray unit without disturbing routine work
- ▶ Consists basically of a transparent ionization chamber and a display unit

Dose area product (DAP) meters and dosimeters, firmly installed to the X-ray unit, make it possible to determine the radiation loads to which patients are exposed during X-ray examinations. Patient exposures can differ in hospital routine practices. The exposures can be reduced by a measuring device informing the practitioner of the total amount of radiation applied to the patient. Especially high dose and high-risk X-ray examinations require such a device.

DIAMENTOR RS-KDK DAP and Dose Meter

Combined dose and dose area product (DAP) meter for patient dosimetry in diagnostic radiology



- ▶ Simultaneous measurements of DAP and dose as well as of the exposure time
- ▶ Automatic air density correction
- ▶ Usage at an extended temperature range
- ▶ Convenient installation via the DIAMENTOR RS connector box

The DIAMENTOR RS-KDK is a measuring system which fully complies with IEC / EN 60580. It features the innovative chamber-in-chamber technology, which PTW invented many years ago. It allows to measure dose and dose rate as well as the dose area product and dose area product rate simultaneously during radiographic and fluoroscopic X-ray procedures.

The DIAMENTOR RS-KDK consists of an ionization chamber with integrated electronics, so it can be used as a built-in DAP solution for fixation under the X-ray tube housing or, transparent for light, it can be firmly fixed to the collimator by adaptation rails. The chamber structures are not shown on the X-ray images.

The system is available with an RS232 or RS485 interface.

Alternatively, the DIAMENTOR BT Interface can be connected to the DIAMENTOR RS-KDK for wireless data transfer via Bluetooth. The DIAMENTOR RS-KDK can either be connected to a PC to read out the values or it can be used in combination with the DIAMENTOR RS-D display unit which features a touch display.

Ordering Information

L981400 Set DIAMENTOR RS-KDK with RS-D, wireless
L981415 Set DIAMENTOR RS-KDK, wireless
L981416 Set DIAMENTOR RS-KDK with RS-D, version RS232
L981417 Set DIAMENTOR RS-KDK with RS-D, version RS485
L981418 Set DIAMENTOR RS-KDK, version RS232
L981419 Set DIAMENTOR RS-KDK, version RS485
E41750B/S/G Service contract Bronze, Silver or Gold

DIAMENTOR® C-RS Wireless DAP System

Compact wireless dose area product (DAP) meter for patient dosimetry in diagnostic radiology



- ▶ Highly integrated electronics
- ▶ Available with RS232 or RS485 interface
- ▶ Optional DIAMENTOR BT interface available for wireless data transfer

The DIAMENTOR C-RS is a highly integrated single channel built-in DAP meter. The electronics is available in two versions with RS485 or RS232 interface. Combined with the DIAMENTOR BT interface, which allows the DIAMENTOR C-RS to be accessed via Bluetooth, wireless communication between the DIAMENTOR C-RS and the control desk is possible.

The miniature DAP meter electronics as well as the DIAMENTOR BT interface can be mounted behind the housing of the X-ray installation.

The wireless DIAMENTOR solution enables convenient and fast installation due to the removal of extension cables.

Ordering Information

L981470 Set DIAMENTOR C-RS, wireless
L981471 Set DIAMENTOR C-RS, version RS232
L981472 Set DIAMENTOR C-RS, version RS485
E41750B/S/G Service contract Bronze, Silver or Gold

DIAMENTOR® Accessories

Optional accessories for DIAMENTOR systems



DIAMENTOR chambers

- ▶ Flat, transparent and rectangular DIAMENTOR chambers size B for firm mounting on the collimator of radiography and fluoroscopy units using appropriate adaptation rails
- ▶ Very low filter absorption and beam hardening effect
- ▶ Chambers and adaptation rails upon request

DIAMENTOR universal mount

- ▶ Easy and flexible adjustment of rail distances between 133 mm and 177 mm are possible
- ▶ Allows the correct arrangement of any filter and the chamber without influencing the measurement
- ▶ Optional rails for use of filters or cones are available

DIAMENTOR chamber adaptation rails

- ▶ Various adaptation rails for different collimators are available
- ▶ Can be screwed easily to the ionization chamber

DIAMENTOR RS232, extension and adapter cable

- ▶ Different lengths are available

DIAMENTOR label printer

- ▶ Various label printer for patient exposure recording are available

Ordering information

Details upon request

Radiation Monitoring



Radiation Monitoring

Radiation Protection Considerations

According to the international ICRP 60 standard¹ radiation exposure to humans has to be as low as reasonably achievable (ALARA principle). Furthermore, the ICRP requires control of risk in the case of potential exposures and observance of certain dose limits.

The available radiation monitoring equipment is quite multifarious depending on the differing characteristics of a multitude of beam qualities and dose rate ranges as well as the variety of measuring tasks. The equipment is used for highly sensitive measurement of natural background radiation or for dose level measurements of artificial radiation sources such as nuclear research laboratories, nuclear power plants and medical irradiation units.

The control of potential radiation expositions and the measurement of radiation loads to persons working in areas of exposure risk are basic requirements of radiation protection procedures. PTW supplies radiation monitoring equipment that helps persons in charge to meet these requirements.

¹ ICRP 60, 1990 Recommendations of the International Commission on Radiological Protection. Report #60

Radiation protection dosimetry

▶ Personal Dosimeters

A variety of pocket-sized and light-weight digital radiation monitors are available for continual personal dosimetry to safeguard all personnel against the hazards of ionizing radiation.

▶ Mobile monitors

Surfaces in radionuclide laboratories such as nuclear medicine laboratories are monitored by the large area contamination monitor.

Portable survey meters enable the user to monitor radiation levels in the environment, e.g., in the surroundings of radiation emitting units.

▶ Stationary monitors

Ionization chambers of various volumes to monitor different gamma levels are used in connection with high quality dosimeters.

Radiation Monitoring

▶ Contamination Monitor	72
▶ STEP OD-02 Survey Meter	72
▶ Thermo FH 40 G-L10 Survey Meter	73
▶ Thermo EPD Mk2 Personal Dosemeter	73
▶ X-Ray Leakage System	74
▶ 3 Liter Chamber	75
▶ 50 Liter Chamber	75
▶ UNIDOS Tango Electrometer	76

Contamination Monitor

Monitor with plastic scintillator for radioactive contamination measurement of surfaces in nuclear medicine laboratories



- ▶ Utilizes a large size thin-layer plastic scintillation detector
- ▶ Does not require detector gas filling or gas flow
- ▶ Measures alpha, beta and gamma radiation using one detector

The portable contamination monitor model CoMo 170 measures alpha, beta and gamma contamination with a high degree of sensitivity, utilizing a thin plastic scintillation detector of 170 cm² measuring area. A background subtraction function with adjustable background measurement time is included. The measuring results are presented on an illuminated large-area graphical LC display. The measurement is menu-prompted, and the measuring data are stored internally. The built-in RS232 interface and optional software make it possible to read and process the data. The monitor is operated by size AA batteries or by rechargeable batteries. The model CoMo 170 D additionally features a built-in GM detector for dose rate measurements in the range of 1 μSv/h ... 20 mSv/h. For stationary use, two types of wall stations are available: a passive wall mount, which just accommodates the monitor, and an active wall mount, which includes a voltage supply. The optional mobile floor control device accommodates the contamination monitor for easy contamination checks of floor areas.

Ordering Information

L991221 Contamination monitor model CoMo 170
L991257 Contamination monitor model CoMo 170 D

Options

L991222 Radioactive check device 200 Bq ⁹⁰Sr
L991223 Stationary wall mount, passive
L991224 Stationary wall mount, active
(mains voltage 115 V or 230 V has to be specified)
L991225 Floor control device

STEP OD-02 Survey Meter

Compact portable ion chamber dosimeter for dose and dose H*(10), H'(0.07, Ω) rate measurements



- ▶ Serves for protection level dosimetry in a wide energy range of 6 keV to 15 MeV of X-rays and gamma rays, above 15 MeV an optional PMMA cap is necessary
- ▶ Measures beta rays in a range of 80 keV to 3 MeV
- ▶ Provides wide measuring ranges for radiation protection levels:
 - Dose: (0 ... 2000) μSv
 - Dose rate: 0 μSv/h ... 2000 mSv/h
- ▶ Measures continuous and pulsed radiation

The STEP survey meter is used for protection level dosimetry in nuclear medicine laboratories and in the environment. Nuclear medicine therapy patients can be checked before release. The instrument is based on a 600 cm³ large volume ionization chamber, which provides high precision and a wide range of health physics measurements. The unit is prepared for chamber volume air density corrections. The chamber can be separated from the display unit and located at a distance of 0.7 m by using the standard extension cable or up to 100 m by using the optional extension cable. The background-illuminated LCD display shows the measuring result in large characters and on a bar graph as well as the operating conditions. The STEP basic set comes with a battery operated display unit, a measuring probe and a carrying case. STEP OD-02 features a smoothing algorithm, simultaneous display of dose rate and dose and the indication of arithmetic mean.

Ordering Information

L991288 STEP survey meter OD-02

Options

L991289 Acrylic plastic shielding for STEP OD-02

Radioactive check device, wall holder set and extension cables in different lengths available upon request

Thermo FH 40 G-L10 Survey Meter

Portable digital survey meter for dose and dose $H^*(10)$ rate measurements



- ▶ Serves in an energy range of 30 keV to 4.4 MeV
- ▶ Fitted with an internal counter tube
- ▶ Provides measuring ranges for radiation protection levels:
 - Dose: (0.1 ... 1000) μ Sv
 - Dose rate: 10 nSv/h ... 100 mSv/h
- ▶ No external probe or cable required for gamma dose rate measurements

The FH 40 G-L10 is a digital survey meter for many different radiation protection applications. It incorporates an energy-filtered proportional detector. It meets the energy response behaviour of the new units ambient dose equivalent and ambient dose equivalent rate ($H^*(10)$). Measured values are shown on a clear, backlit LCD display including a 3 decade logarithmic bargraph. An intelligent algorithm detects and indicates small changes in dose rate, suppressing random noise.

The FH 40 G-L10 records up to 256 data points containing measurement number, date, time and dose rate. The stored values can be read directly from the display of the device and can also be transferred to a PC via a serial IR interface. The IR interface cable and the software are available as options. The survey meter is rugged, light-weight and easy to operate with large keys.

Ordering Information

- L991382 Survey meter FH 40 G-L10
- L991383 Survey meter FH 40 G-L10
with official German authority calibration

More models, external detectors, connection cables and software available upon request

Thermo EPD[®] Mk2 Personal Dosemeter

Electronic personal dosemeter for $H_p(10)$ and $H_p(0.07)$ readouts of gamma, beta and X-radiation



- ▶ Highly sophisticated multi-functional personal radiation monitor for radiotherapy, nuclear medicine and X-ray diagnostic
- ▶ Modern detector technology: PIN diode detector
- ▶ Measures $H_p(10)$ and $H_p(0.07)$ according to ICRP
- ▶ Programmable by external readers
- ▶ Various audible and visual alarms configurable
- ▶ All readers are supplied with the software EasyEPD2
- ▶ Display units: Sv and rem
- ▶ Dose indication range: 0 μ Sv ... 16 Sv
- ▶ Dose measuring range: 10 μ Sv ... 10 Sv
- ▶ Dose rate range for dose measurement: 0 μ Sv/h ... 4 Sv/h
- ▶ Display resolution: 1 μ Sv
- ▶ Energy range:
 - 15 keV ... 10 MeV (gamma and X-ray)
 - 250 keV ... 1.5 MeV (beta)
- ▶ Dose alarm thresholds:
 - 2 x $H_p(10)$ and 1x $H_p(0.07)$ values, programmable
- ▶ Dose rate alarm threshold:
 - 2 x $H_p(10)$ and 1x $H_p(0.07)$ values, programmable
- ▶ Power supply: 1 battery AA, alkal. 1.5 V or 3.6 V LTC
- ▶ Acoustic alarm: approx. 98 dB(A) at 20 cm distance
- ▶ Dimensions: 85 mm x 63 mm x 19 mm
- ▶ Weight (incl. battery): approx. 95 g (with clip)

Ordering Information

- L991017 Thermo EPD Mk2 Electronic personal dosemeter
- L991362 Thermo EPD Mk2 Electronic personal dosemeter
with official German authority calibration
- L991295 Thermo EPD Basic IrDa Reader, USB
- L991294 Thermo EPD Desktop Reader, USB

Digital readers upon request

XLS X-Ray Leakage System

Multi-channel measuring system for radiation leakage measurements of diagnostic X-ray installations

- ▶ Measures dose and dose rate at 18 locations around diagnostic X-ray tubes simultaneously
- ▶ High sensitivity and excellent long-term stability
Complies with IEC 60601-1-3
- ▶ Full software control via the RS232 interface

Manufacturers of diagnostic X-ray tubes must ensure that the leakage radiation emitted by the tube outside the useful beam does not exceed certain levels provided by law or by standards such as IEC 60601-1-3. The XLS X-ray leakage system is an effective device to fulfill these requirements. The XLS Measuring unit consists of a specialized multi-channel dosimeter and an 18 channel measuring extension to connect up to 18 XLS ionization chambers. The system measures dose and dose rate or charge and current of all 18 chambers simultaneously. The maximum and minimum measuring results are displayed together with the channel numbers. A built-in high voltage supply for 400 V chamber polarizing voltage is included in the base unit. The measuring results of all chambers can be read via an RS232 interface. The chamber calibration factors are stored in the device and can be read and modified via the serial interface.

The rectangular plane-parallel XLS ionization chamber is used for the XLS X-ray leakage system. The central electrode has an active area of 20 cm x 5 cm. The chamber response is approx. 10 $\mu\text{C}/\text{Gy}$. The external chamber dimensions are 225 mm x 90 mm x 35 mm. The dose rate measuring range of the chamber connected to the XLS electronic devices is from 0.15 mGy/h to 30 mGy/h, and the chamber current measuring range is from 0.4 pA to 100 pA.

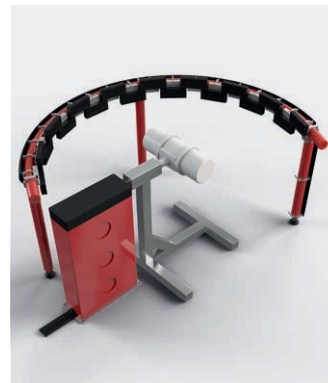
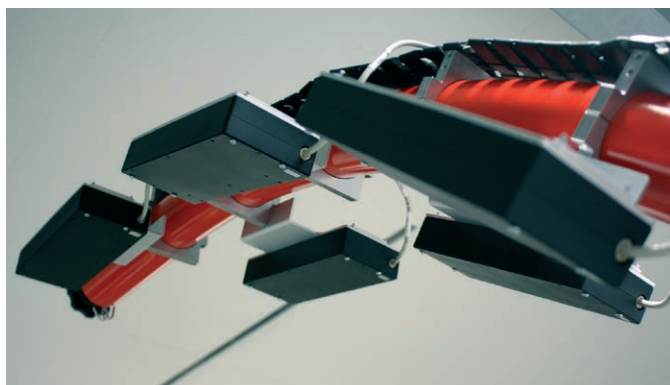

Up to 18 chambers can be mechanically arranged on a semi-circular arch of 1 m radius according to IEC. The X-ray tube is positioned on a rotatable table and – while the table is continuously rotated – the XLS leakage system monitors the dose rate of all detectors and records the radiation levels of the entire hemisphere around the X-ray tube. The rotatable table and the chamber fixation parts are neither part of the XLS chambers nor the XLS X-ray leakage system.

The individual response and the long-term stability of the chambers can be checked by means of an appropriate adapter between a radioactive check source type T48010 or T8921/8922 and the chambers type TA34055-0. PTW can provide customized solutions including measuring unit, ionization chambers, connection cables, rotation unit, C-arc and software.

Ordering Information

T11066	XLS Measuring unit
T26014.1.001-15	Cable set, 15 m length
T26014.1.001-20	Cable set, 20 m length
TA34055-0	XLS Ionization chamber
T26014.1.200-15	Cable for X-ray leakage system, 15 m length
T26014.1.200-20	Cable for X-ray leakage system, 20 m length

Option

T48011	Chamber adapter for radioactive check source
--------	--

Information about customized parts like rotation units and C-arcs upon request

3 Liter Chamber

Cylindrical polyethylene ionization chamber for stationary radiation monitoring of gamma radiation



- ▶ Vented sensitive volume of 3 liters
- ▶ Suitable as radiation monitoring chambers
- ▶ Gamma energy range 80 keV to 1.3 MeV

The 3 liter chamber is used as stationary surveillance device for environmental radiation monitoring. The chamber is designed to measure protection level dose rates. The response is $1 \cdot 10^{-4}$ C/Sv. The maximum dose rate at 90 % saturation is 10 Sv/h. The chamber is fully guarded up to the measuring volume. Since the sensitive volume is open to the surroundings, air density correction is required for precise measurement.

The cylindrical chamber is made of graphite coated polyethylene with 4 mm wall thickness. The ion-collecting electrode is made of graphite coated polyethylene too. The external chamber diameter is 150 mm and the length is approx. 200 mm. For the transfer of the measuring signal and the polarizing voltage, the chamber is supplied with two coaxial connectors. The maximum length of an extension cable to connect a dosimeter is 100 m. The maximum chamber polarizing voltage is 1000 V.

The chamber is supplied with an integrated adapter for positioning a radioactive check source of type T48010, which make it possible to check the proper performance of the entire measuring system.

Ordering Information

T34031 Monitoring chamber 3 l,
2 Fischer coax connectors

Option

T7262/U10-1.5 Connection cable with M connector,
length 1.5 m

50 Liter Chamber

Cylindrical pressurized steel ionization chamber for stationary gamma radiation monitoring

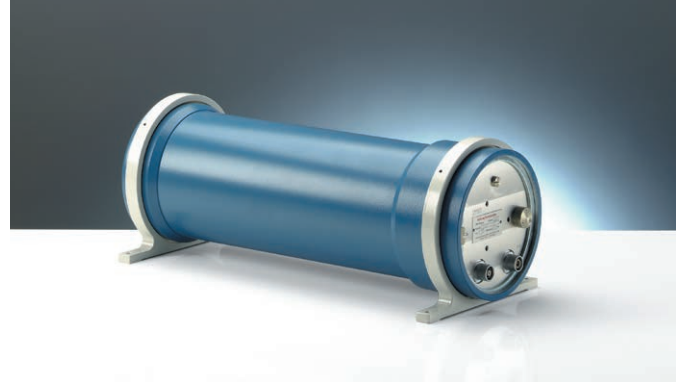

- ▶ Sealed sensitive volume of 50 liters
- ▶ Suitable as stationary radiation monitoring chamber
- ▶ Gamma energy range 80 keV to 1.3 MeV

The ionization chamber T7262 has a constructive volume of 5 liters filled with Argon gas at the pressure of 10 bar, resulting in an effective measuring volume of 50 liters. This superior design makes the chamber very sensitive and enables performing low level gamma radiation measurements down to the natural radiation background. The chamber is used as highly sensitive stationary surveillance device for environmental radiation monitoring. The response is $2 \cdot 10^{-3}$ C/Sv. The maximum dose rate at 90 % saturation is 10^{-2} Sv/h. The chamber is fully guarded up to the measuring volume. Since the sensitive volume is sealed, no air density correction is required.

The cylindrical 50 liter chamber is made of steel with 3.25 mm wall thickness and a 3 mm aluminum cover. The ion-collecting electrode is made of brass. The external chamber diameter is 195 mm and the length is 538 mm. The chamber is supplied with two coaxial Fischer connectors for the transfer of the measuring signal and the polarizing voltage. Via an optional adapter cable of 1.5 m length, the chamber can be connected to a dosimeter with M connector, which has input circuits on ground potential. The maximum length of an extension cable is 100 m. The maximum chamber polarizing voltage is 1000 V.

Ordering Information

T7262 Radiation monitoring chamber 50 l
T7262A Radiation monitoring chamber 50 l with
integrated adapter for check device T48010

Option

T7262/U10-1.5 Connection cable with M connector,
length 1.5 m

UNIDOS Tango

Reference Class Electrometer

Smart secondary standard reference class electrometer exceeding IEC 60731 and IPEM standards



- ▶ Reference class electrometer fully compliant with IEC 60731, IEC 61674, IEC 62467-1, IEC 60846 and JSMP (JCSS calibration needed)
- ▶ Secondary standard electrometer according to IPEM
- ▶ Automated detector management with Intelligent Detector Recognition (IDR)
- ▶ Best available resolution of 0.1 fA in the market
- ▶ Built-in webserver and LAN interface
- ▶ Can be controlled via smart device or PC (WLAN and LAN)
- ▶ Touchscreen with excellent readability from any viewing angle

UNIDOS Tango is a secondary standard reference class electrometer which meets and exceeds both IEC and IPEM performance requirements. With the best available resolution in the market of 0.1 fA, it is the perfect choice for high-precision measurements, e.g., in small field dosimetry.

UNIDOS Tango automates detector management and identification using Intelligent Detector Recognition. Simply scan the data matrix code on your calibration certificate or detector label with the built-in camera, and a new detector is added to the database or the right detector chosen for measurement. With its built-in webserver and LAN interface, UNIDOS Tango provides full remote control capabilities. Change settings or start measurements conveniently from your PC, view results instantly on your tablet or smartphone.

Ordering Information

L981629 UNIDOS Tango, connecting system M
L981630 UNIDOS Tango, connecting system BNT
L981631 UNIDOS Tango, connecting system TNC

Options

T10052.1.040 Carrying case
E41100B/S/G Service contract Bronze, Silver or Gold

Metrology

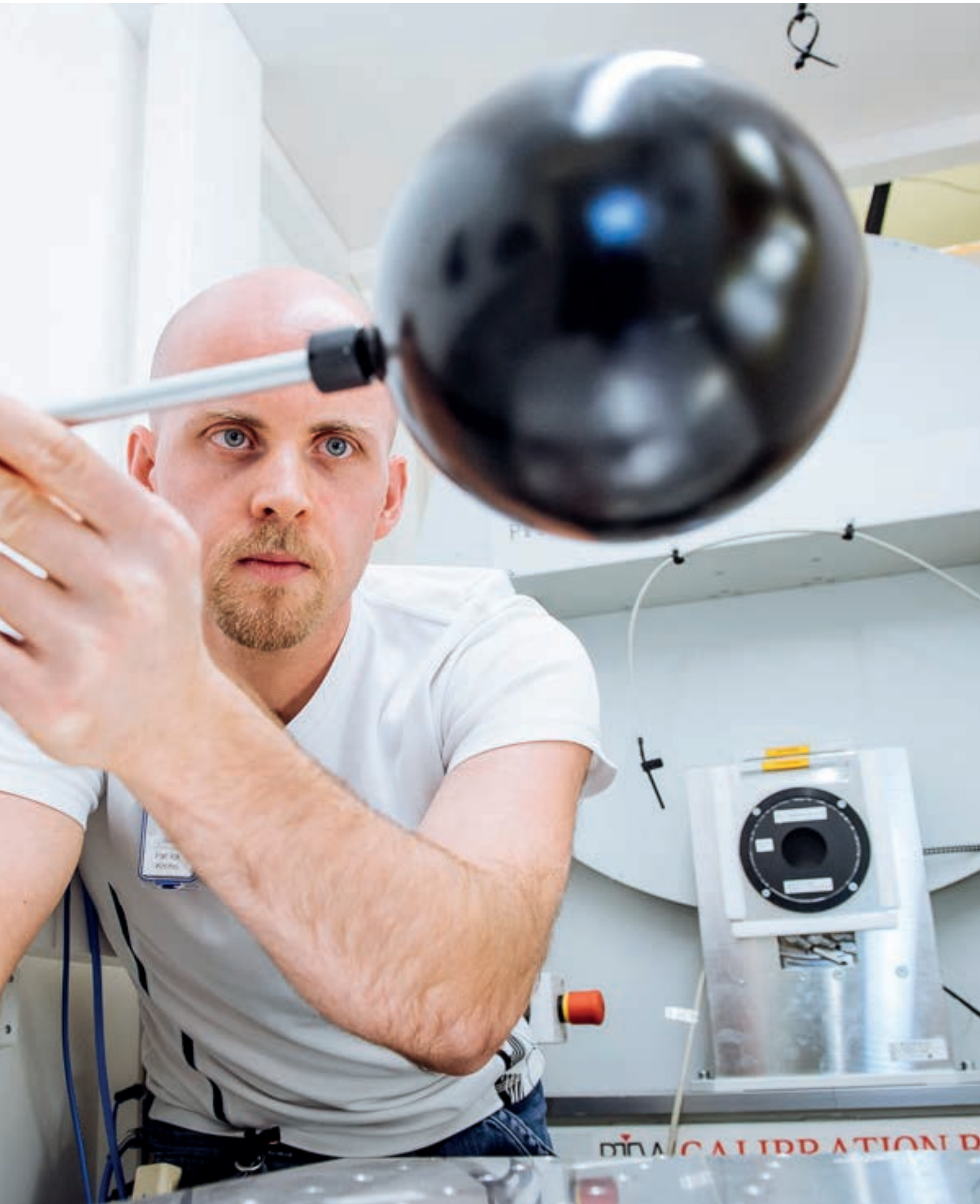

Radiological Calibration

Calibration Facilities

Radiation detectors and dosimeters are usually calibrated on a calibration bench for correct dose measurement. The bench is combined with a radiation source for defined irradiation of the dosimeters that are to be calibrated. The calibration source is a ^{60}Co source or a ^{137}Cs source, each delivering only one radiation energy, or an X-ray tube, delivering a range of X-ray energies by varying the high voltage and filter settings. Different X-ray beam qualities require different filtration. For this reason a filter wheel, which can move diverse filters into the X-ray beam, is mounted in front of the X-ray tube. A stable support is required to install the X-ray tube together with its heavy lead shielding into the right position. For dose comparison, a reference chamber is mounted in the beam. This chamber is designed as a shadow-free transmission chamber and has to be calibrated traceable to a primary standard.

For calibration, the detectors are fixed on a carriage that can be precisely moved on the rails of the calibration bench by remote control to realize different distances from the radiation source and to establish different dose rates.

PTW's product range comprises calibration benches and accessories, as well as a variety of reference ionization chambers for calibration purposes.

Calibration Services

The PTW calibration laboratory is accredited by the IAEA, the International Atomic Energy Agency, Vienna, as a member of the IAEA/WHO international network of Secondary Standard Dosimetry Laboratories (SSDL) for dose quantities in radiation therapy.

The PTW calibration laboratory is also accredited by the Federal Institute of Metrology, Braunschweig (PTB), which is the German National Laboratory.

PTW operates Germany's first Secondary Standard Dosimetry Laboratory for radiation quantities accredited by the DAkkS (German Calibration Service), under direct supervision of the National Laboratory.

With eleven calibration benches in continual use, the PTW calibration laboratory is one of the most active calibration laboratories for ionizing radiation in the world. The calibrations are directly traceable to the primary standards of PTB and BIPM (Bureau International de Poids et Mesure, Paris, France).

The PTW calibration laboratory has a long history. From its very beginning, PTW has always maintained a calibration laboratory for radiation measuring quantities. Although it is an integral part of the company and its comprehensive quality assurance system, the calibration laboratory is proud of its own tradition and achievements. Internal traceability is extended to the point of preserving the original measurement notes for every calibration performed since 1937.

Metrology

▶ VF CB-60 CALIBRATION BENCH	80
▶ X-Ray Irradiator for Calibration Facilities	81
▶ VF GI-07 Universal Gamma Irradiator	82
▶ VF GI-02 Dual Source Gamma Irradiator	82
▶ VF IG-13 Basic Gamma Irradiator	83
▶ VF PGI-01 Panoramic Gamma Irradiator	83
▶ UJP TERABALT High Level Gamma Irradiator	84
▶ Beta Irradiators	84
▶ VF NI-01 and NI-08 Neutron Irradiator	85
▶ VF RMS Monitoring System	85
▶ Accessories for Calibration Facilities	86
▶ Reference Dosimetry Equipment	86
▶ ISO Calibration Phantoms	87
▶ H _p (10) Secondary Standard Chamber	87
▶ Calibration Service – Laboratory	88
▶ Calibration Service – Radiation Qualities	88
▶ PTW Service Contracts	89

VF CB-60 CALIBRATION BENCH

Calibration bench with carriage for precise calibration of dosimeters used for ionizing radiation measurement

- ▶ Versatility, possibility of calibrating various devices from various manufacturers
- ▶ Made for X-ray, gamma and neutron laboratories
- ▶ Reliability and precise positioning
- ▶ Safe, automated remote control
- ▶ Possibility of uneven floor compensation

The CB-60 CALIBRATION BENCH is typically a part of a complete calibration facility which can be delivered by PTW with many options as a turnkey project.

The high precision CB-60 CALIBRATION BENCH is designed as a very stable construction on steel rails used for accurate positioning of radiation detectors. Different types of bench models are available, allowing manual or software controlled 3D movements and optionally rotation too. Both types of benches allow the positioning of the detector in the beam in X, Y and Z direction.

Standard technical parameters

Track length up to 12 m
Position adjustment accuracy < 1 mm
Track gauge 600 mm
Radiation beam height 1500 mm
Horizontal detector positioning +/- 300 mm
Vertical detector positioning +/- 150 mm
Worktable load capacity 50 kg
Power supply 230 VAC (optionally 110 VAC)
Communication interface Ethernet and RS232

The DARS software allows to control benches and irradiators and to read out the dosimeter UNIDOS dosimeters such as temperature and pressure.

Implemented batch modes allow an automatic user defined calibration workflow with the DARS PROFESSIONAL software.



Ordering Information

L991453-X	CB-60 calibration bench, manual
L991454-X	CB-60 calibration bench, s/w controlled "-X" stands for the length in m
L991513	Local controller for automatic CB-60

Options for all benches

X100008	Connection modules for dosimeters (system M or/and TNC), customized
L991455	Option automatic rotation
L991456	Lateral movement extension for CB-60
L991457	Camera on CB-60 bench carriage

Control and processing software

L991481	DARS BASIC CONTROL software for equipment control only
L991482	DARS EASY software with record and verify functionality
L991483	DARS PROFESSIONAL software with advanced features
L992010	Data Logger 600-1100 hPa testo 176 P1 TPH incl. DAkKS calibration

X-Ray Irradiator for Calibration Facilities

System to accommodate an X-ray tube, X-RAY SHUTTER, FILTER WHEEL and a monitor chamber

The X-ray irradiation system is intended for precise, comfortable and safe calibration of X-ray dosimeters used in X-ray diagnostics, radiation therapy as well as for health physics measurements. Working together with VF's calibration bench CB-60 it is designed even in fully automatic mode with relatively high throughput.

The software DARS BASIC allows to comfortably operate the bench and the irradiator (incl. SHUTTER and FILTER WHEEL) as well as to acquire relevant measurement data.

- ▶ Basic construction with X-ray tube support and shielding cabinet
- ▶ Number of tubes: max. 3
- ▶ Standard X-ray tubes: < 50 / 160 / 225 / 320 / 450 kV
- ▶ Lead shielding: 8 mm Pb
- ▶ Beam axis height above the floor: 1.5 m
- ▶ Up to 3 FILTER WHEELS with 24 positions each
- ▶ Filters for calibrations for X-ray radiation qualities available
- ▶ High speed X-RAY SHUTTER: < 100 ms, up to 450 kV
- ▶ Holding device for a monitor chamber (optionally temperature value acquisition possible)
- ▶ Open field size at 50 cm focus distance: 10 cm
- ▶ Standard diaphragm field sizes at 50 cm: 2, 4, 8 cm
- ▶ Weight complete, with one filter wheel: < 450 kg
- ▶ Max. setup dimensions: 157 cm x 60 cm x 235.1 cm

X-RAY SHUTTER, FILTER WHEEL are controlled by the BENCH CONTROL UNIT via network cable with TCP/IP interface. The BENCH CONTROL UNIT is connected via one network cable with the PC.

The DARS BASIC CONTROL software controls all technology manually: all movements, incl. the bench, the safety, electrometers and readout of the temperature and pressure, X-ray generator (ISOVOLT Titan|neo only, work in progress). In addition. the DARS PROFESSIONAL software provides a batch mode that allows an automatic calibration with pre-defined filter positions at predefined distances and X-ray settings (ISOVOLT Titan|neo only, work in progress) and shutter control. Furthermore, the managing of the the calibration certification is possible.



Ordering Information

X-ray tube support:

L981442	for Waygate ISOVOLT 160 M2
L981252	for YXLON YTU/160-D02
L981383	for Waygate ISOVOLT 225 M2
L981288	for Waygate MXR320/26
L981293	for YXLON YTU/320-D03
L981289	for a tube specified by the customer
L981437	Mammography tube changer
T90012	X-RAY SHUTTER, software controlled
L981194	FILTER WHEEL, software controlled
T90011TTP	Control Unit with baro- and thermometers
L991481	DARS BASIC CONTROL software
L991483	DARS PROFESSIONAL software

Filter and sets:

T43033-MMXX	Filter for FILTER WHEEL (MM = material, XX = thickness in mm)
L981583	ISO 4037 Filter N40-N200
L981640	ISO 4037 N40-N300
L981584	ISO 4037 N10-N30
L981652	ISO 4037 W30-W300
L981579	Diagn. Filter IEC61267 RQR
L981580	Diagn. Filter IEC61267 RQA
L981581	CT Filter IEC61267 RQT
L981582	CT Filter IEC61267 RQT w/o RQR
L981194	FILTER WHEEL, software controlled

X-ray systems and accessories:

L991498	Waygate ISOVOLT titan neo 160kV
L991499	Waygate ISOVOLT titan neo 225kV
L991497	Waygate ISOVOLT titan neo 320kV
L991496	Option cooling for ISOVOLT titan neo
L992007	Mo-X-ray System 60kV
L991485	W-X-ray System 60kV
L991486	Rh-X-ray System 60kV
L999032	Cooling unit mammography tubes

Measuring instruments:

L991495	High Voltage Divider 160/225kV
L991279	Oscilloscope HDO6054B, calibrated
L981283	PicoScope 4262- 16 bit, 5 MHz, 2 channels
E21337	DAkKS calibration PicoScope 4262
L992010	Data Logger THP testo 171 P1
TM786	Monitor chamber type 786
TW34014	Monitor chamber type 34014
L9816xx	UNIDOS Tango (M: xx=29, TNC: xx = 31)

VF GI-07 Universal Gamma Irradiator

Universal gamma isotope irradiator for calibration facilities



- ▶ Number of sources: max. 7
- ▶ Max. sources activity ^{137}Cs 100 TBq
- ▶ Max. sources activity ^{60}Co 30 TBq
- ▶ Beam axis height 1.5 m above floor
- ▶ Weight with double shielding for 100 TBq ^{137}Cs : 1.5 t (max. 25 GBq ^{60}Co) ... 2.7 t (max. 2.5 TBq ^{60}Co)
- ▶ Dimensions (W x L x H): 80 cm x ≤ 84.5 cm x 127 cm
- ▶ Collimator complying with ISO 4037:2019 with lead collimator, tungsten optionally
- ▶ Surface dose rate 100 TBq ^{137}Cs : ≤ 0.1 ... 1 $\mu\text{Sv/h}$ (depends on selected shielding)
- ▶ Surface dose rate for ^{60}Co : ≤ 7 ... 10 $\mu\text{Sv/h}$ (depends on selected source strength and shielding)
- ▶ Fully automated irradiation process

The GI-07 irradiator is a universal multisource gamma irradiator for health physics calibrations with a collimated beam for dose rates from tenths of $\mu\text{Gy/h}$ up to units of Gy/h .

Ordering Information

- L991510 VF GI-07 Gamma Irradiator L
total activity ^{137}Cs : 20 TBq and ^{60}Co : 0.3 TBq
- L991511 VF GI-07 Gamma Irradiator H
total activity ^{137}Cs : 200 TBq and ^{60}Co : 30 TBq

Options

- X100008 Integrated beam axis laser
- X100008 Set of attenuators, manual or remote, max. atten. 5000, 2-4 attenuators
- X100008 Tungsten collimator (inst. lead)

Suggestion of standard sources

- ^{60}Co : 18.5 GBq (0.5 Ci), 185 MBq (5 mCi)
- ^{137}Cs : 3 TBq (81 Ci), 185 GBq (5 Ci), 0.5 GBq (0.014 Ci)

VF GI-02 Dual Source Gamma Irradiator

Dual source gamma irradiator for calibration facilities

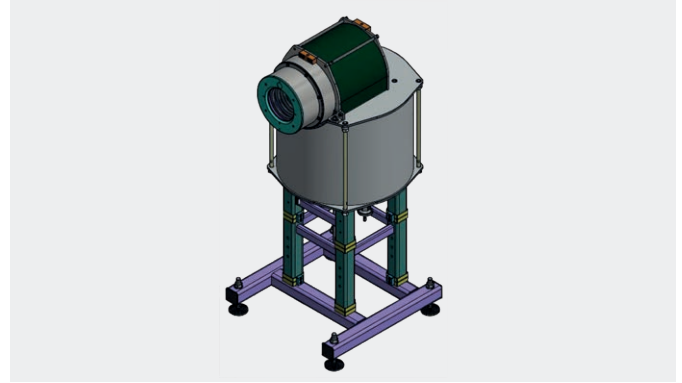

- ▶ Number of sources: max. 2
- ▶ Max. activity of one source ^{137}Cs 200 TBq
- ▶ Max. activity of one source ^{60}Co 30 GBq
- ▶ Beam axis height 1.5 m above floor
- ▶ Weight with standard double shielding: 1.18 t (max. 0.3 GBq ^{60}Co / 20 TBq ^{137}Cs) ... 2.8 t
- ▶ Dimensions (W x L x H): 80 cm x ≤ 74 cm x 171 cm
- ▶ Collimator complying with ISO 4037:2019 made of lead, tungsten optionally
- ▶ Low surface dose rate: < 100 $\mu\text{Sv/h}$
- ▶ Fully automated irradiation process

The GI-02 irradiator is an economical dual source gamma irradiator for health physics calibrations with a collimated beam for dose rates from tenths of $\mu\text{Gy/h}$ up to units of Gy/h at a reduced irradiator weight.

Ordering Information

- L991478 VF GI-02 Gamma Irradiator L
total activity ^{137}Cs : 20 TBq and ^{60}Co : 0.3 TBq
- L991494 VF GI-02 Gamma Irradiator M
total activity ^{137}Cs : 200 TBq and ^{60}Co : 3 TBq
- L991475 VF GI-02 Gamma Irradiator H
total activity ^{137}Cs : 200 TBq and ^{60}Co : 30 TBq

Options

- X100008 Integrated beam axis laser
- X100008 Set of attenuators, manual or remote, max. atten. 5000, 2-8 attenuators
- X100008 Tungsten collimator (inst. lead)

Suggestion of standard sources

- ^{60}Co : 18.5 GBq (0.5 Ci), 185 MBq (5 mCi)
- ^{137}Cs : 3 TBq (81 Ci), 185 GBq (5 Ci), 0.5 GBq (0.014 Ci)

VF IG-13 Basic Gamma Irradiator

Basic Gamma irradiator for calibration facilities



- ▶ Number of sources: max. 3
- ▶ Max. activity of one source ^{137}Cs 5 TBq
- ▶ Max. activity of one source ^{60}Co 20 GBq
- ▶ Beam axis height 1.3 m above floor
- ▶ Weight with standard double shielding 1.2 t
- ▶ Dimensions: 188 x 57 x 74 cm (h x w x d)
- ▶ Collimator complying with ISO 4037 or GOST 8.087-2000
- ▶ Narrow beam collimator ISO 4037: ($\varnothing_{\text{In}} \times \varnothing_{\text{Out}} \times l$) 6 x 13 x 26 cm (type C-300)
- ▶ Beam collimator GOST 8.087-2000: ($\varnothing_{\text{In}} \times \varnothing_{\text{Out}} \times l$) 9 x 9 x 22.5 cm (type C-330)
- ▶ Surface dose rate for ^{137}Cs : < 1 $\mu\text{Sv/h}$
- ▶ Surface dose rate for ^{60}Cs : < 10 $\mu\text{Sv/h}$
- ▶ Fully automated irradiation process

The IG-13 irradiator is a basic gamma irradiator for health physics which provides a collimated beam and dose rates from tenths of $\mu\text{Gy/hr}$ up to Gy/hr at low budget.

Ordering Information

L991461 VF IG-13 Basic Gamma Irradiator

Suggestion for sources

L991468 ^{137}Cs 2.5 TBq (67.6 Ci)
L991470 ^{137}Cs 20 GBq (0.54 Ci)
L991471 ^{137}Cs 0.5 GBq (0.014 Ci)
L991477 ^{60}Co 1.85 GBq (0.05 Ci)

VF PGI-01 Panoramic Gamma Irradiator

Panoramic gamma isotope irradiator for calibration facilities



PGI-01 irradiator is primarily intended for the calibration and testing of personal dosimeters with a non-collimated source or can be used as a general panoramic source of gamma radiation. For this purpose, PGI-01 has to be fitted with a suitable radionuclide.

One ^{137}Cs or ^{60}Co source can be installed into the irradiator. There are fixed or rotary tables for simultaneous irradiation of multiple dosimeters and attenuators for the dose rate reduction available.

- ▶ Number of sources: 1
- ▶ Max. activity ^{137}Cs 3 TBq (81 Ci) or ^{60}Co 300 GBq (8.1 Ci)
- ▶ Badge dosimeter calibration w/table 20 pcs/cycle
- ▶ Attenuators for dose rate reduction (10x, 100x)
- ▶ Weight: < 600 kg (^{137}Cs source) or 1300 kg (^{60}Co source)
- ▶ Dimensions: ($\varnothing \times h$) 53.8 x 120 cm
- ▶ Low surface dose rate < 10 $\mu\text{Sv/h}$

Semi-automatic calibration workplace:

It is possible to set up an efficient semi-automatic system for busy workplaces using electronic readout of the values measured. The system records the exposure time of dosimeters and calculated exposure values. The installed reader identifies semi-automatically each dosimeter and records the respective measured value. The tolerance limits, data storage link, label print and other settings can be preset in the system.

Ordering Information

L991462 VF PGI-01 Panoramic Gamma Irradiator

Suggestion for sources

L991474 ^{60}Co 185 GBq (5 Ci)

UJP TERABALT High Level Gamma Irradiator

Radiation therapy level ^{60}Co irradiator for calibration facilities



The TERABALT T-100 represents a laboratory irradiator which serves for applications where “hard” gamma radiation of ^{60}Co (1.17 and 1.33 MeV) is used. Primarily, the T-100 is designed for calibration laboratory needs.

- ▶ Number of sources: 1
- ▶ Max. activity: 560 TBq (15 kCi) ^{60}Co
- ▶ Beam axis height: 1.5 m above floor
- ▶ Weight: approx. 1850 kg
- ▶ Dimensions: 115 × 90 × 200 cm (l x w x h)
- ▶ Power supply: 230 VAC, max. 8 A
- ▶ Collimator: 25° (optionally decreased)
- ▶ Low surface dose rate

Ordering Information

L991463 UJP TERABALT

Suggestion for sources

L991473 ^{60}Co 260 TBq (~7 kCi)

Beta Irradiators

Beta irradiator for calibration facilities

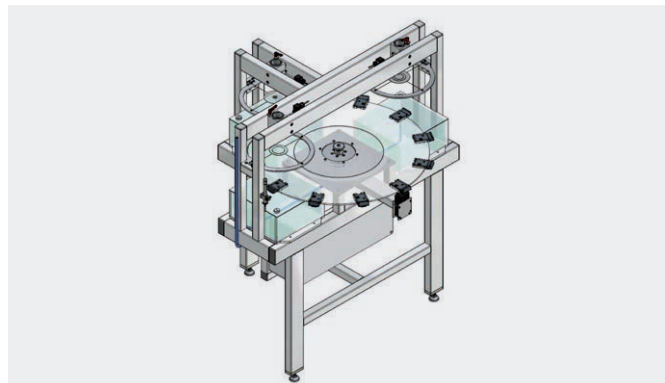

The EZAG BSS-2 Beta Secondary Standard Irradiator is a worldwide common referential standard.

The VF Industrial Beta Irradiator is similar to the BSS-2 design but optimized for industrial beta calibration of personal dosimeters in a fully automated process.

Sources included in below irradiators:

- ^{147}Pm : 3.7 GBq (0.1Ci),
- ^{85}Kr : 3.7 GBq (0.1Ci),
- $^{90}\text{Sr}/^{90}\text{Y}$: 460 MBq (12.7 mCi)

EZAG BSS-2 Beta Secondary Standard Irradiator:

- ▶ For single dosimeter calibration acc.ISO 6980
- ▶ Designed and calibrated by PTB
- ▶ Beam flattening filters, one for each source

VF Industrial Beta Irradiator:

- ▶ Principle similar to BSS-2
- ▶ For ISO 6980 Hp(0.07) personal dosimeter calibrations
- ▶ Automatic irradiation of 12 personal dosimeters
- ▶ Traceability to PTB (cross calibration against a BSS-2)

Ordering Information

L991464 EZAG BSS-2

Due to exclusive distribution rights the EZAG BSS-2 might not be available from PTW in all countries of the world.

L991465 VF Beta Irradiator

VF NI-01 and NI-08 Neutron Irradiators

Single source irradiator NI-01 and multiple source irradiator NI-08 for neutron calibration facilities

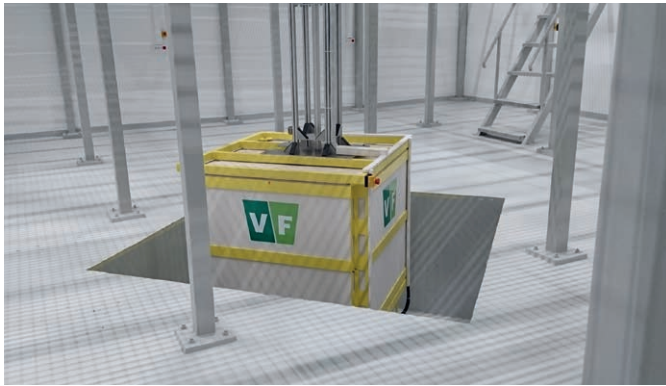

- ▶ Number of sources: 1 ... 7, (NI-08 also for gamma)
- ▶ Accreditation according to ISO 17025 possible
- ▶ Sturdy safety interlocks
- ▶ Safe source position under the floor or above
- ▶ Low dose rate in 1 m distance from irradiator: < 5 $\mu\text{S}/\text{h}$
- ▶ Max. source activity ($^{239}\text{PuBe}$): 240 GBq, NI-08 185 GBq
- ▶ Standard beam axis height: 1.5 m
- ▶ Weight approx. NI-01: 800 kg, NI-08: 3,600 kg
- ▶ Overall dimensions (H x W x L):
NI-01: 210 cm x 80 cm x 80 cm
NI-08: 1150 cm x 140 cm x 140 cm
NI-08 source container: 200 cm x 140 cm x 140 cm

Typical needs for neutron calibration facilities

- ▶ Irradiation room acc. ISO 8529 (15 m x 15 m x 15 m)
- ▶ Irradiation control room and an operator workstation
- ▶ Irradiator with neutron radiation source (NI-01 or NI-08)
- ▶ Calibration bench(es) made of light material (CB-60)
- ▶ Safety system
- ▶ Radiation monitoring system

Ordering Information

L991476 Neutron single source irradiator NI-01
X100008 Neutron single source irradiator NI-08
L991481 DARS BASIC CONTROL software
L991482 DARS EASY software
L991483 DARS PROFESSIONAL software

Accessories

L991454-x Automatic Calibration Bench CB-60
L991519 Safety system for calibration lab
L992011 Neutron single source irradiator NI-02
L999xxx RMS (e.g. RDU22+MDN-01+ASU-50)

Suggestion for sources

$^{241}\text{Am}/\text{Be}$: 185 GBq, ^{252}Cf : 5.15 GBq

VF RMS Monitoring System

Radiation monitoring system for calibration facilities



- ▶ Smart dose rate meters for X-ray, gamma and neutron
- ▶ Local archiving of data, statuses and logs
- ▶ Smart probe ranges
MDG-04: 0.1 $\mu\text{Gy}/\text{h}$... 1 Gy/h
MDG-08: 0.01 $\mu\text{Sv}/\text{h}$... 1 Sv/h
MDN-01: 0.1 $\mu\text{Sv}/\text{h}$... 100 mSv/h
- ▶ Displaying of the measured data, status and historical data including tables and graphs
- ▶ Alerts if the preset alarm levels are exceeded (optical and acoustical) to warn local personnel
- ▶ Process parameter setting via touch screen

The VF RMS Radiation Monitoring System is a standardized system for monitoring the radiation situation. Various radiation monitors, display units and signaling units can be connected to the system.

Due to its modular concept, the VF RMS enables wide variety of configurations, meaning that the whole system can be customized for different radiation monitoring applications.

Ordering Information

L999029 RDU-22 Radiation Display Unit
L999025 MDG-04 X-ray and Gamma Detector
L999026 MDG-04 FD, failsafe
L999030 MDG-08 X-ray and Gamma Detector
L999031 MDG-08 FD, failsafe
X100008 MDN-01 Neutron Dose Rate Meter
L999028 ASU-50 Alarm slave unit for RMS systems
L991484 RMS software

Accessories for Calibration Facilities

Cameras, lasers and safety system and other accessories



TCP/IP camera monitoring system

State-of-the-art high resolution room surveillance and display read out camera system

L998091 Camera monitoring system

Camera for installation on calibration bench

For reading dosimeter display, with manual focus, including small for visualization at the calibration bench

L991457 Camera on CB-60 bench carriage

Chamber holder set

For mounting chambers on the carriage in the beam

L981237 Chamber holder set for calibration bench

Lasers

For display of reference distance and cross hair on the beam axis. Necessary for positioning reference of detector installed on the calibration bench carriage

L991298 Laser alignment system LAP ASTOR Line
L991323 Laser alignment system LAP ASTOR Cross
L991299 LAP ASTOR laser ceiling mount
L991433 Point laser for calibration labs LSA-02
L992005 Cross laser for calibration labs LSA-02
L992006 Line laser for calibration labs LSA-02

Safety

Safety components for calibration laboratories such as door lock, entry door sensor, key lock, active motion sensors, signalization units, emergency brakers

L991519 Safety system for calibration lab

Reference Dosimetry Equipment

Ionization chambers, monitor chambers and phantoms for reference dosimetry

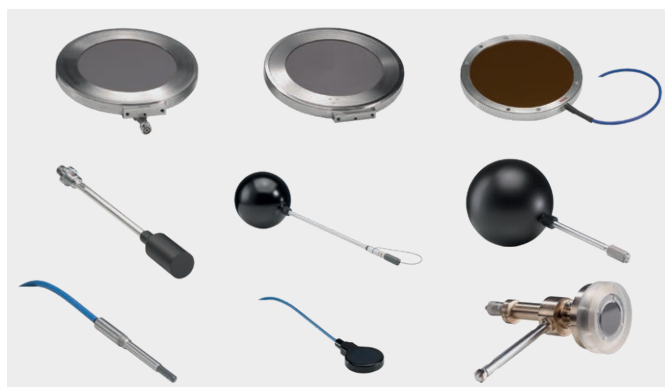

PTW provides a wide range of detectors for ionizing radiation. The product range includes detectors for monitoring of useful beam and reference dosimetry

Monitor chambers available for measurements of useful X-ray beam in dosimetry laboratories include:

86 cm³ Monitor Ionization Chamber, type 34014

94 cm³ Monitor Chamber, type 786

17.6 cm³ X-ray Therapy Monitor Chamber, type 7862

Detectors available for reference measurements in primary or secondary standard dosimetry laboratories include:

30 cm³ Cylinder Stem Ionization Chamber, type 23361

27.9 cm³ TK-30 Spherical Ionization Chamber, type 32005

1 Liter Spherical Ionization Chamber, type 32002

10 Liter Spherical Ionization Chamber, type 32003

10 cm³ Spherical Chamber, types 32008S

50 cm³ Spherical Chamber, types 32007S

Böhm Extrapolation Chamber, type 23392

H_p(10) Secondary Standard Chamber, L981937 or L981938

6 cm³ SFD Mammo Chamber, type 34069

3.14 cm³ CT Chamber, type 30009

0.02 cm³ Soft X-ray Chamber, type 23342

0.005 cm³ Soft X-ray Chamber, type 34013

0.6 cm³ Farmer Chamber, type 30013

Phantoms and electrometers available for reference measurements in primary or secondary standard dosimetry laboratories include:

ISO water slab phantom, representing a torso, type 41007

ISO water pillar phantom, representing arm/leg, type T41011

ISO acrylic rod phantom, representing a finger, type T40009

UNIDOS Tango Reference Class Electrometer

ISO Calibration Phantoms

Standard test phantoms representing parts of human bodies with regard to back-scattering of incident radiation

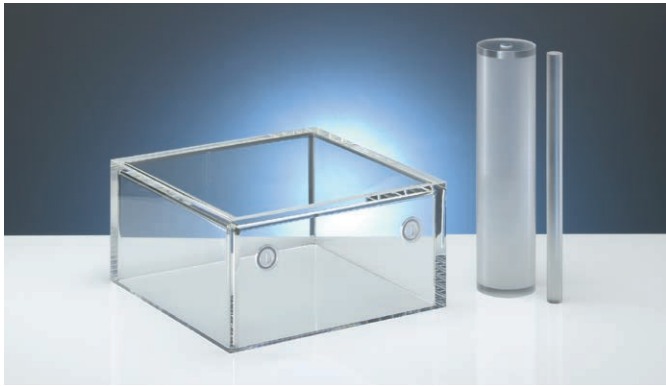

- ▶ Comply with the standard ISO 4037 part 3¹
- ▶ Represent parts of human bodies with regard to back-scattering of the incident radiation
- ▶ Suitable for calibrations and type tests of personal dosimeters, because they measure the quantities
- ▶ $H_p(0.07)$ and $H_p(10)$

The ISO calibration phantoms comply with the standard ISO 4037 part 3¹ which describes standard test phantoms for calibration and type tests of personal dosimeters, that measure the dose quantities $H_p(0.07)$ and $H_p(10)$. The phantom composition is acrylic material (PMMA). Three types representing parts of human bodies in regard to back-scattering of incident radiation are available:

- ▶ Slab phantom: The water slab phantom represents the human torso and consists of a 300 mm x 300 mm x 150 mm cube, which is filled with water. The front wall is 2.5 mm thick; all other walls are 10 mm thick.
- ▶ Pillar phantom: The water pillar phantom represents a lower arm or leg and consists of a circular cylinder with 73 mm diameter and 300 mm length, which is filled with water. The wall is 2.5 mm thick; the bottom and cover plates are each 10 mm thick.
- ▶ Rod phantom: The acrylic rod phantom represents a finger and consists of a circular acrylic cylinder with 19 mm diameter and 300 mm length.

¹ ISO 4037-3:1999 "X and gamma reference radiation for calibrating dosimeters and dose rate meters and for determining their response as a function of photon energy – Part 3: Calibration of area and personal dosimeters and the measurement of their response as a function of energy and angle of incidence"

Ordering Information

T41007 ISO water slab phantom, representing a torso
T41011 ISO water pillar phantom, representing arm and leg
T40009 ISO acrylic rod phantom, representing a finger

$H_p(10)$ Secondary Standard Chamber

Parallel plate ionization chamber for direct measurement of $H_p(10)$ personal dose equivalent on a slab phantom



- ▶ Vented sensitive volume of 10 cm³
- ▶ Measures the $H_p(10)$ personal dose equivalent directly
- ▶ Suitable as a reference chamber for $H_p(10)$ calibration

The parallel plate ionization chamber model 34035¹ is integrated into a slab phantom to measure the $H_p(10)$ radiation protection measuring quantity directly. The high performance chamber is designed to be used as a secondary standard chamber for calibration purposes. The beam calibration with the $H_p(10)$ chamber makes it unnecessary to precisely determine the spectrum of the X-ray beam. The chamber comes uncalibrated; a primary standard calibration by PTB, the German National Laboratory, is available. The useful gamma energy range is from 10 keV to 1400 keV. The chamber response is approx. 350 nC/Sv. The chamber set includes a phantom slab of 31 mm thickness with chamber assembly and an additional phantom slab of 120 mm thickness. The slab phantom is composed of tissue-equivalent acrylic material (PMMA). The total external dimensions are 300 mm x 300 mm x 151 mm. Both sets include an adapter cable to connect the chamber either to a dosimeter with M connector or with BNC connector and banana pin. The $H_p(10)$ chamber should be used in connection with a high quality dosimeter such as UNIDOS or UNIDOS E to ensure best performance.

¹ Ankerhold, Ambrosi, Eberle – A chamber for determining the conventionally true value of $H_p(10)$ and $H^*(10)$ needed by calibration laboratories – Rad. Prot. Dos. Vol. 96, Nos 1-3, pp. 133–137 (2001), Nucl. Techn. Publishing

Ordering Information

L981937 $H_p(10)$ Secondary standard chamber, M connector
L981938 $H_p(10)$ Secondary standard chamber, BNC connector and banana pin

Option

PTB Primary standard calibration upon request

Calibration Service - Laboratory



- ▶ PTW-Freiburg is a member of the IAEA international SSDL network and the German Calibration Service DAkkS
- ▶ The calibrations are directly traceable to the primary standards of:
 - BIPM (Bureau International de Poids et Mesure, Paris)
 - PTB-Braunschweig (German Federal Institute of Physics and Metrology)
- ▶ Eleven calibration facilities for various radiation qualities, measuring quantities and dose rate ranges are available
- ▶ Regular external audits are performed by PTB

The calibration laboratory has been a most important part of PTW-Freiburg since its first days. The task to produce accurate dosimetric instrumentation implies the necessity to provide accurate calibration. PTW-Freiburg operates Germany's first Secondary Standard Dosimetry Laboratory for radiation quantities accredited by the DAkkS German Calibration Service, under direct supervision of the National Laboratory. It operates as an ADCL (Accredited Dosimetry Calibration Laboratory) and it is also a member of the international SSDL network, organized by the International Atomic Energy Agency IAEA. With eleven calibration benches in continual use, the PTW calibration lab is one of the most active calibration labs for ionizing radiation in the world. The following radiation therapy beam qualities can be calibrated:

- ▶ ^{60}Co (1.3 MeV)
- ▶ ^{137}Cs (662 keV)
- ▶ X-rays (10 ... 280) kV

In addition, well-type chambers can be calibrated to measure brachytherapy sources. Besides the therapy dosimetry calibrations, the PTW lab provides for dose and non-invasive kV calibrations in diagnostic imaging, nuclide radioactivity calibrations of isotope calibrators in nuclear medicine and calibrations of health physics dosimetry equipment.

Calibration Service - Radiation Qualities

A variety of ionizing radiation beam quality sets for different applications is available

Radiation Therapy Dosimeters

X-rays	10, 15, 30, 50, 70, 100 kV (TW qualities according to DIN 6809-4)
X-rays	70, 100, 140, 200, 280 kV (TH qualities according to DIN 6809-5)
^{137}Cs	662 keV
^{60}Co	1.3 MeV

Diagnostic Radiology Dosimeters

X-rays	50, 70, 90, 120, 150 kV Conventional (RQR and RQA qualities according to IEC 61267)
X-rays	70, 90, 120, 150 kV CT (RQR and RQA qualities according to IEC 61267)
X-rays	100, 120, 150 kV CT (RQT qualities according to IEC 61267)
X-rays	50, 70, 90 kV Dental
X-rays	25, 28, 30, 35 kV Mammography Qualities according to IEC 61267 Mo/Mo, Mo/Rh, Mo/Cu, Mo/Al, Rh/Ag, Rh/Cu, Rh/Rh, W/Ag, W/Al, W/Rh, W/Ti, W/Cu (each with 2 mm Al optional)

Radiation Protection Dosimeters

X-rays	10, 20, 30, 40 kV (Narrow Spectrum Series (N) qualities acc. ISO 4037-1:1996)
X-rays	60, 80, 100, 150, 200, 250, 300 kV (Narrow Spectrum Series (N) qualities acc. ISO 4037-1:1996)
^{137}Cs	662 keV
^{60}Co	1.3 MeV

Miscellaneous Calibrations

- ▶ Source strength ($\text{cGy}^2\text{h}^{-1}$) of brachytherapy sources measured by well-type chambers
- ▶ Diagnostic X-ray generator high voltage of all types of X-ray equipment measured non-invasively by kV-meters
- ▶ Nuclide activity in nuclear medicine measured by isotope calibrators (only CURIEMENTOR instruments)
- ▶ Electrical measuring quantities charge (C) and current (A) measured by highly sensitive electrometers

General Information

According to the PTW definition, each such set of beam qualities represents one calibration point for a certain application and can be ordered with a single ordering number. For more detailed information please refer to "Calibration at PTW - A Short Guide" which you will find in the section Services-Calibration on our website ptwdosimetry.com.



PTW Service Contracts

Service Contracts with different service levels: Bronze, Silver and Gold



PTW instruments are a valuable investment. Keep your PTW equipment in top condition to get the best out of it as long as you use it. PTW service contracts hold the key to it. They come in three attractive contract packages that are built on each other to meet different maintenance and budget needs – from basic coverage to total care.

BRONZE – The “Extended Warranty” Package

The PTW service contract “Bronze” offers prolonged protection against unexpected repair costs after the statutory warranty has expired. Extend your coverage further and benefit from the expertise of our technical support and free software updates.

Services include:

- ▶ Technical hotline support
Unlimited access to support hotline via phone, fax and e-mail
- ▶ Warranty extension
Free repair and/or equipment replacement warranty
- ▶ Software updates
Free provision of updated versions of licensed PTW software

SILVER – The “Stay Save” Package

The PTW service contract “Silver” combines the advantages of the “Bronze” service package with regular service checks. In addition to priority support and repairs, it includes inspection and calibration of your instruments, as well as free software upgrades. Perfect for those who want to keep their PTW system always in top condition and technically up to date.

Services include:

- ▶ All the advantages of the “Bronze” service package
- ▶ Software upgrades
Free provision of further developed versions of licensed PTW software
- ▶ Service checks
Inspection and calibration of measuring instruments in recommended service intervals
- ▶ Priority service and support
Guaranteed, faster reaction time to support, service and repair requests

GOLD – The “Total Care” Package

The “Gold” service contract provides the highest level of protection for your investment which gives you true peace of mind. Building on the “Silver” package, it includes free replacement equipment, covering all shipping costs within the EU. Reduce the risk of unplanned downtime of your PTW equipment during servicing or off-site repairs. Shipment is handled by us, freeing you up to focus on your core business.

Services include:

- ▶ All the advantages of the “Silver” service package
- ▶ Loan equipment
Fast provision of replacement equipment during off-site repairs and servicing at no extra cost
- ▶ Logistical services
Free shipping within the EU and full logistical and administrative support in the event of servicing

For more information about PTW service contracts and other PTW services, visit our website at ptwdosimetry.com or contact your local PTW sales partner.

Quick View



Quick View

Product Families

The PTW product range is quite comprehensive. It meets the tasks and needs of users for the measurement of ionizing radiation and the quality control of irradiation equipment in medicine and health physics.

The products are presented in this catalog in the order of their application and use. This chapter includes listings of certain product families and reviews the entire range of the presented product families. Each product is characterized within these reviews by a small picture, the item number, the product name, a short description and the page, where the product is described more comprehensively.

This chapter reviews the following product families:

▶ **TBA Therapy Beam Analyzers**

Various sets of basic equipment for data acquisition and analysis of external beams in radiotherapy are available, depending on different types of phantom tanks. Optional items for the TBA analyzers are also listed.

▶ **PTW Dosemeters**

This guide gives a review of the available dosemeters, which are combined with different detectors for the measurement of ionizing radiation of varying radiation qualities and dose rates.

▶ **PTW Software**

Since the majority of electronic devices for the measurement of ionizing radiation is computer controlled, a number of software programs for various applications in medicine and health physics are available.

Quick View

▶ TBA Therapy Beam Analyzers Systems	94
▶ TBA Therapy Beam Analyzers Options	95
▶ Guide to PTW Dosemeters	96
▶ Guide to PTW Software	97
▶ Product Index	98
▶ Item Number Index	99

TBA Therapy Beam Analyzers



Configured Basic Systems



- L981475 BEAMSCAN Water Phantom, complete, BNT connector
 L981476 BEAMSCAN Water Phantom, complete, TNC connector
 L981474 BEAMSCAN Water Phantom, complete, M connector
 consisting of:
- BEAMSCAN phantom tank
 - Lifting carriage with integrated dosimeter, control unit and reservoir
 - Mobile device (iPod touch®), WiFi access point
 - 2x Semiflex 3D 0.07 cm³ ion chamber, TRUFIX BS
 - BEAMSCAN Software, software option PLAMO
 - Accessories



- L981558 BEAMSCAN MR Water Phantom for Elekta, complete
 L981559 BEAMSCAN MR Water Phantom for Viewray, complete
 consisting of:
- BEAMSCAN MR phantom tank
 - Carriage with integrated dosimeter, control unit and reservoir
 - 2x Semiflex 3D 0.07 cm³ ion chamber
 - BEAMSCAN Software, software option PLAMO
 - Accessories



- L981172 MP3-XS Water Phantom, complete, BNT connector
 L981173 MP3-XS Water Phantom, complete, TNC connector
 L981174 MP3-XS Water Phantom, complete, M connector
 consisting of:
- MP3-XS phantom tank
 - TBA control unit, TANDEM dosimeter, control pendant
 - 2x Semiflex 3D 0.07 cm³ ion chamber
 - BEAMSCAN Software
 - Accessories



- L981199 MP3-T Water Phantom, complete, BNT connector
 L981183 MP3-T Water Phantom, complete, TNC connector
 L981182 MP3-T Water Phantom, complete, M connector
 consisting of:
- MP3-T phantom tank
 - TBA control unit, TANDEM dosimeter, control pendant
 - PinPoint ion chamber 0.03 cm³ ion chamber
 - SFD Mammo ion chamber 6 cm³
 - BEAMSCAN Software, software option TomoTherapy
 - Accessories







- L981403 MP3-P Water Phantom, complete, M connector
 L981526 MP3-PL Water Phantom, complete, M connector
 consisting of:
- MP3-P or MP3-PL phantom tank
 - SCANLIFT carriage with integrated reservoir
 - TBA control unit, TANDEM XDR, dosimeter, control pendant
 - 2x Bragg Peak 10.5 cm³ ion chamber
 - MEPHYSTO mc², software option Reference Dosimetry
 - Accessories

For product details see chapter Therapy Beam Analysis, page 23ff





TBA Therapy Beam Analyzers

Dosimetry Options



		page
	Dosimetry diodes 60023 microSilicon Diode Detector for electrons and photons; BNT, TNC or M connector 60022 microSilicon X Diode Detector for photons; BNT, TNC or M connector	15
	Thimble ionization chambers 31021 Semiflex 3D 0.07 cm ³ ion chamber; BNT, TNC or M connector 30013 Waterproof Farmer 0.6 cm ³ ion chamber; BNT, TNC or M connector 31022 PinPoint 3D 0.016 cm ³ ion chamber; BNT, TNC or M connector	15
	Plane-parallel ionization chambers 34045 Advanced Markus 0.02 cm ³ electron chamber; BNT, TNC or M connector 34001 Roos 0.35 cm ³ electron chamber; BNT, TNC or M connector	15
	Diamond detector 60019 microDiamond; BNT, TNC or M connector	15
	Detector positioning tools L981150 TRUFIX Basic equipment Holders for various detectors upon request	29

Guide to PTW Dosemeters

Therapy Dosemeters

				page
	L981629 M L981630 BNT L981631 TNC	UNIDOS Tango Reference Class Electrometer	Smart secondary standard reference class electrometer exceeding IEC 60731 and IPEM standards	13
	L981632 M L981633 BNT L981634 TNC	UNIDOS Romeo Reference Class Electrometer	Standard reference class electrometer exceeding IEC 60731	13
	T10011 M T10015 BNT T10016 TNC	TANDEM	Fast dual channel electrometer for reference dosimetry with TanSoft software and for beam analysis with TBA therapy beam analyzers; chamber bias voltage supply \pm (0 ... 400) V	14
	T10037 M T10038 BNT T10039 TNC	TANDEM XDR	Fast dual channel electrometer for reference dosimetry with TanSoft software and for beam analysis with TBA therapy beam analyzers; chamber bias voltage supply \pm (0 ... 400) V; extended dose rate range for e.g. IORT	14





Diagnostic Dosemeters

				page
	L981815	NOMEX Multimeter	Miniaturized non-invasive measuring system for reference dosimetry and quality control in X-ray diagnostic radiology	53
	T11062 (RS232) T11064 (RS485)	DIAMENTOR RS-KDK	Combined dose and dose area product (DAP) meter for patient dosimetry in diagnostic radiology	67
	T11059 T11058	DIAMENTOR C-RS	Compact wireless dose area product (DAP) measuring system for patient dosimetry in diagnostic radiology	67

Health Physics Dosemeter

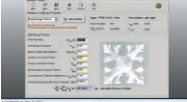
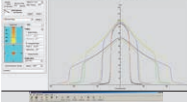
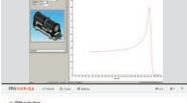
				page
	L981629 M L981630 BNT L981631 TNC	UNIDOS Tango Reference Class Electrometer	Smart secondary standard reference class electrometer exceeding IEC 60731 and IPEM standards	76

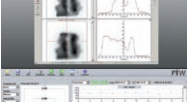
Guide to PTW Software

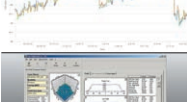
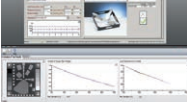
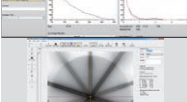
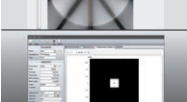
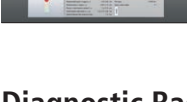
Radiation Therapy				page
	S080028	TanSoft	Reference dosimetry with the TANDEM dual channel dosimeter	14
	S100009	UniSoft Edition 2000	Absorbed dose to water calculation according to AAPM TG-51 and IAEA TRS-398	14
		BEAMSCAN Software	Therapy beam data acquisition and data analysis, part of the BEAMSCAN System	24
	S080052	PeakScan	Measurement and analysis of the Bragg peak with the PEAKFINDER	27
	S070031	VERIQA	All-in-one solution for integrated patient QA	40
	S070009	VeriSoft	IMRT patient plan verification, DVH 4D option available	41
	S070017	QUICKCHECK Software	LINAC constancy tests with the QUICKCHECK weblene constancy test device	42
	S070027	Track-it	Software for QA data tracking	41
	S070011	MultiCheck	LINAC quality control with the 2D ion chamber arrays	45
	S070010	epidSoft	Quality control of Electronic Portal Imaging Devices (EPID) using the EPID QC Phantom	46
	S070019	IsoCheck Software	Checks size and position of the isocenter by analysing starshot images	47
	S070023	IsoCheck epid	Determination of radiological rotational isocenters of LINACs by analysing EPID images	47

Diagnostic Radiology page

	S030008	NOMEX Software	Control of the NOMEX Multimeter and data handling incl. statistics and data export	51
---	---------	----------------	--	----

Metrology page

	L991481 L991482 L991483	DARS Software	Controls benches, irradiators and reads out dosimeter	80
---	-------------------------------	---------------	---	----

Product Index

Product	Page	Product	Page
1 liter chamber	86	Micro-CT Phantom	63
10 liter chamber	86	microDiamond	15
3 liter chamber	75	microSilicon	15
4D dose verification	35	Mini phantom	18
50 liter chamber	75	Monitor chamber	86
Advanced Markus chamber	15	Monitoring system	85
Al filter	56	MP1	16, 28
Barometer	19	MP3-P	26
BEAMSCAN	23	MP3-PL	26
BEAMSCAN MR	25	MP3-T	28
BEAMSCAN software	24	MP3-XS	26
Beta irradiator	84	MR products	25, 36, 43
Böhm extrapolation chamber	86	MultiCheck	45
Bone Density Calibration Phantom	63	Neutron Irradiator	85
BQ-CHECK	44	NOMEX mAs	53, 59
Bragg peak chamber	27	NOMEX Multimeter	53, 59
Brass mini phantom	18	NORMI 13	60
BRONZE package	89	NORMI 3D	61
Build-up cap	16	NORMI MAM	62
Calibration bench	100	NORMI RAD/FLU	60
Calibration bench	80	OCTAVIUS 4D	35
Calibration phantom	87	OCTAVIUS accessories	39
Calibration service	88	OCTAVIUS Detector 1000 SRS	37
Camera monitoring system	86	OCTAVIUS Detector 1500	36
Centric cross	62	OCTAVIUS Detector 1500 MR	36
Chamber array	36-39, 42-43	OCTAVIUS Detector 1500 XDR	38
Check device	19	OCTAVIUS Detector 1600 SRS	37
CoMo 170	72	OCTAVIUS Detector 1600 XDR	39
Cone-Beam Phantom	63	OCTAVIUS I	36-37
Contamination monitor	72	OCTAVIUS II	38
CT dosimetry	55	PEAKFINDER	27
CT test object	63	Personal dosimeter	73
CTDI equipment	55	PinPoint chamber	15
Cu filter	56	QRM Phantom	63
Cylinder stem chamber	86	QUICKCHECK webline	42
DAP meter	67	R/F/D detector	54
DAP/Dose meter	67	Radioactive check device	19
DARS software	80	Roos chamber	15
Data Logger	19	RUBY phantom	33
Diagnostic Dosimeter	53, 59	RW3 slab phantom	18
DIAMENTOR	67	SC holding device	48
Diamond detector	15	SCANLIFT	26
Diode	15	Semiflex chamber	15
Dosimetry diode	15	Service contract	89
DVT test object	61	SFD chamber	54
Electron chamber	15	Silicon Detector	15
Electron Density Phantom	63	SILVER package	89
EPD Mk2	73	SL Survey Detector	72-73
EPID QC Phantom	45	Slab phantom	18
epidSoft	46	Soft X-ray chamber	15
ESTRO mini phantom	18	SOURCECHECK	48
European Spine Phantom	63	Spectral CT Phantom	63
Extension Cable	15	Spherical chamber	86
Extrapolation chamber	86	STARCHECK	42-43
Farmer chamber	15	STEP OD-02	72
FFF compensator	42	Surveillance camera	86
FH 40 G-L10	73	Survey meter	72-73
FIELDCHECK	44	TANDEM	14
Film digitizer	30	TBA software	24
Film measurement	39	Test pattern	62
Filter set	81	Thermometer	19
Filter wheel	81	TK-30 chamber	86
Gamma irradiator	82-84	Track-it	41
GOLD package	89	T-REF chamber	15
Health physics dosimeter	76	TRUFIX	29
H _r (10) secondary standard chamber	87	Tube support	81
HVL measuring stand	55	UNIDOS Romeo	13
IGRT QC set	46	UNIDOS Tango	13, 76
Illuminance meter	84	UniSoft	14
Image ruler	62	Universal dosimeter	13, 76
Irradiator	82-85	Universal gantry mount	48
ISO calibration phantom	87	Universal mount	68
Isocenter QA software	47	Verification software	41
ISOCHECK	47	VERIQA	40
IsoCheck epid	47	VeriSoft	41
IsoCheck software	47	VF irradiator	81-85
Label printer	68	Water column	27
Laser	86	Water phantom	16-17, 23, 25-26, 28
Luminance meter	64	Well-type chamber	48
MAM detector	54	X-Check DSA	61
Mammo test object	62	XLS	74
Markus chamber	15	X-ray leakage system	74
mAs meter	53, 59	X-RAY SHUTTER	81
MAVOLUX	64	X-ray test object	60-62
MAVO-SPOT	64	X-ray test pattern	62
Measuring stand	55		

Item Number Index

Item #	Page	Item #	Page	Item #	Page	Item #	Page
786	86	L981437	81	L991382	74	T26077-0,3	54
7862	86	L981438	35	L991383	74	T26078-0,3	54
23342	15	L981441	27	L991398	40	T26079-0,3	54
23361	86	L981442	81	L991433	86	T2954/K3	15
30009	55	L981449	36	L991453	80	T2967/12	18
30010	15	L981450	38	L991454	80	T29672	18
30012	15	L981464	38	L991455	80	T31016.1.300	18
30013	15	L981465	37	L991456	80	T33005.1.020	48
31010	15	L981470	67	L991457	86	T34031	75
31013	15	L981471	67	L991461	83	T34069.1.050	54
31015	15	L981472	67	L991462	83	T40009	87
31021	15	L981473	60	L991463	84	T40016	55
31022	15	L981474	23	L991464	84	T40016.1.010	55
31024	15	L981475	23	L991473	84	T40017	55
31025	15	L981476	23	L991474	83	T40017.1.010	55
32002	86	L981488	43	L991475	82	T40023.1.010	18
32003	86	L981489	36	L991476	85	T40023.1.020	18
32005	86	L981492	62	L991478	82	T40023.1.030	18
33005	48	L981495	63	L991481	80	T40027	55
34001	15	L981496	63	L991482	80	T40027.1.050	55
34013	15	L981526	26	L991483	80	T40036.1.010	18
34014	86	L981529	53, 59	L991484	85	T40036.1.020	18
34045	15	L981530	53, 59	L991485	81	T40042.1.010	39
34069	54	L981533	53, 59	L991486	81	T40046	62
34070	15	L981558	25	L991494	82	T40052	44
34080	15	L981559	25	L991495	81	T40053	39
34089	27	L981561	35	L991496	81	T40054.1.015	39
34091	29	L981562	35	L991497	81	T40056.1.002	35
60004	54	L981570	35	L991498	81	T40056.1.003	35
60005	54	L981579	81	L991499	81	T40056.1.006	35
60019	15	L981580	81	L991510	82	T40056.1.007	35
60022	15	L981581	81	L991511	82	T40059	43
60023	15	L981582	81	L991513	80	T40063.1.002	35
32007523392	86	L981583	81	L991519	86	T40063.1.003	35
320085	86	L981584	81	L992005	86	T40063.1.004	35
34070-2,5	27	L981585	39	L992006	86	T40064	18
E21271	48	L981599	53, 59	L992007	81	T40072.1.001	34
E21272	48	L981600	53, 59	L992009	19	T40072.1.030	34
E21337	81	L981606	53, 59	L992010	19	T40072.1.100	34
L656004	30	L981610	53, 59	L992011	85	T40072.1.200	34
L659005	62	L981611	53, 59	L998091	86	T40072.1.300	34
L659035	62	L981612	53, 59	L999025	85	T40072.1.400	34
L659066	62	L981613	53, 59	L999026	85	T40072.1.500	34
L659093	62	L981614	53, 59	L999028	85	T40072.1.800	34
L959150	62	L981617	53, 59	L999029	85	T40073	55
L981023	37	L981618	53, 59	L999030	85	T41001	17
L981097	46	L981626	35	L999031	85	T41007	87
L981150	29	L981627	37	L999032	81	T41011	87
L981172	26	L981629	13, 76	S070009	41	T41019	16, 28
L981173	26	L981630	13, 76	S070009.001	35, 41	T41021.1.030	48
L981174	26	L981631	13, 76	S070010	46	T41021.1.070	48
L981182	28	L981632	13	S070011	45	T41021.1.110	48
L981183	28	L981633	13	S070019	47	T41021.1.150	48
L981194	81	L981634	13	S070023	47	T41021.1.170	48
L981199	28	L981636	34	S070027	42	T41021.1.210	48
L981237	86	L981637	34	S070031.010	40	T41023	17
L981246	60	L981638	34	S070031.020	40	T41025	28
L981247	60	L981640	81	S070031.030	40	T41026	16
L981252	81	L981648	26	S080028	14	T41026.1.001	28
L981257	27	L981649	26	S080032	37	T41026.1.100	28
L981283	81	L981650	26	S080052	27	T41049	27
L981288	81	L981652	81	S080054.001	24	T42003	61
L981289	81	L981654	34	S080054.002	24	T42003.1.006	61
L981293	81	L981660	34	S080054.003	24	T42004	47
L981301	60	L981815	53, 59	S100009	14	T42025	45
L981302	60	L981937	87	T10011	14	T42030	44
L981309	60	L981938	87	T10015	14	T42031.1.310	42
L981324	37	L981956	56	T10016	14	T42031.1.320	42
L981377	43	L981957	56	T10033.1.050	43	T42037	47
L981383	81	L981975	42	T10033.1.150	43	T42038	61
L981389	42	L981976	42	T10033.1.550	43	T43009.1.910	56
L981400	67	L991221	68	T10033.3.052	43	T43010.1.001	62
L981403	26	L991222	68	T10037	14	T43033	81
L981406	42	L991223	68	T10038	14	T48010	19
L981415	67	L991224	68	T10039	14	T48011	74
L981416	67	L991225	68	T10052.1.040	13	T48012	19
L981417	67	L991257	68	T11066	74	T7262	75
L981418	67	L991279	81	T20002	54	T7262/U10-1.5	75
L981419	67	L991288	68	T20008	55	T90011TTP	81
L981423	26	L991289	68	T20008.1.020	55	T90012	81
L981425	46	L991298	86	T26005.1.001	15	TA34055-0	74
L981426	62	L991299	86	T26014.1.001	74		
L981429	35	L991323	86	T26014.1.200	74		

The item numbers of most of the detectors are without the leading letters indicating the connecting system.



Making Radiation Safer.

PTW is a global market leader for dosimetry and quality control solutions in radiation medicine, serving the needs of medical radiation experts in more than 160 countries worldwide. Starting with the famous Hammer dosimeter in 1922, the German manufacturer is the pioneer in medical radiation measurement, known for its unparalleled quality and precision.

For PTW, making medical radiation safer is both a passion and lifetime commitment. The family-run high-tech company operates the oldest and largest accredited calibration laboratory in the field of ionizing radiation and established THE DOSIMETRY SCHOOL to globally promote the exchange of knowledge in clinical dosimetry.

For more information on our products visit ptwdosimetry.com or contact your local PTW representative: ptwdosimetry.com/en/contact-us/local-contact

PTW Freiburg GmbH
Lörracher Str. 7
79115 Freiburg · Germany
Phone +49 761 49055-0
info@ptwdosimetry.com
ptwdosimetry.com

© PTW. All Rights Reserved. Specifications subject to change without prior notice.
All trademarks mentioned in this document are the property of their respective owners.
D587.211.00/13 2022-12

PTW THE
DOSIMETRY
COMPANY